

# Groovy Wall Panels



From the grooves cut into the panel to the threads of the polyester felt, the Groovy Wall Panel is all about adding texture to the room. Mounted to the wall of a restaurant or of a fitness centre, Groovy keeps only the good vibrations and reduces the ones that cause discomfort.

# How to Specify

Step by step instructions on how to specify Groovy Wall Panels.

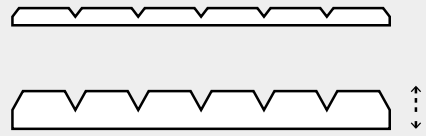

**01**

**Choose a thickness.**

(pg 03)

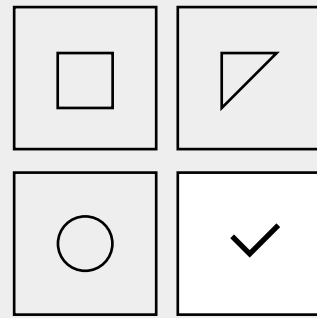

**02**

**Choose a panel design.**

(pg 04)

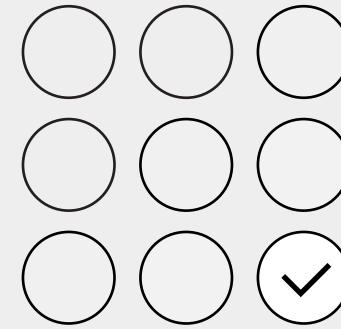

**03**

**Choose a colour.** (pg 05)

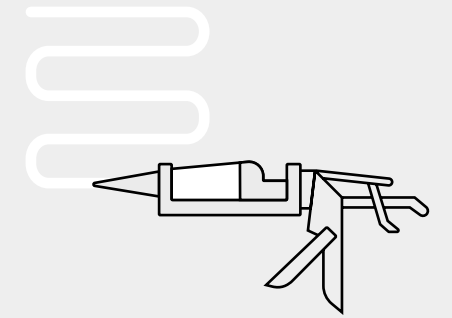

**04**

**Choose an installation method.** (pg 06)

# Dimensions

## Standard Dimensions (mm)

1200 W x 2745 H

1200 W x 300 H

## Standard Thicknesses (mm)

12, 18 and 24

## Edge Detail

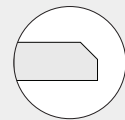

Bevel Edge

## Customization

Panel Width and Height can be adjusted to fit your space.

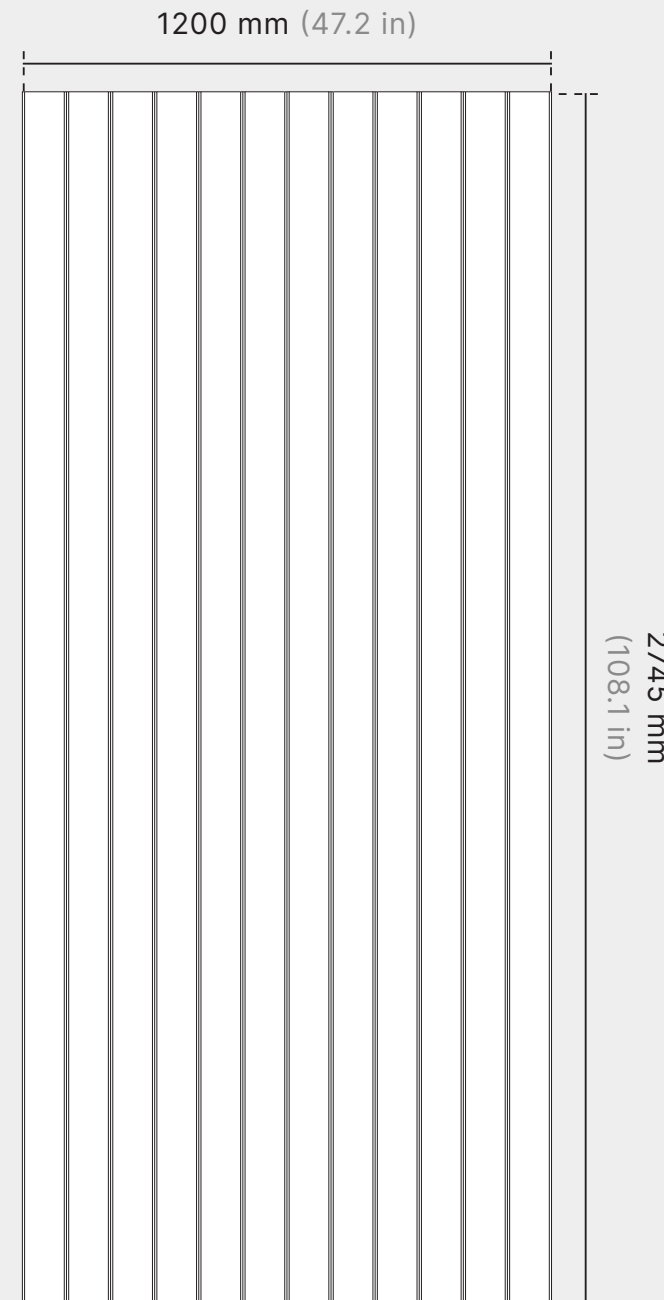
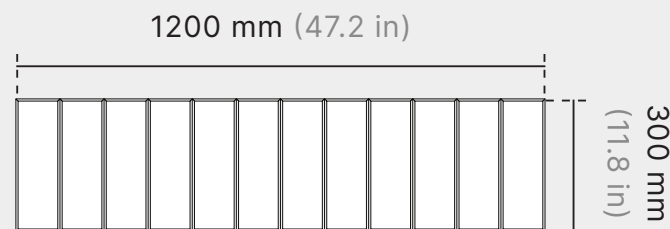

\* Groovy Wide panel design shown here

# Panel Designs

Groovy comes in two standard designs which feature differing spacing between grooves.

Groovy Narrow

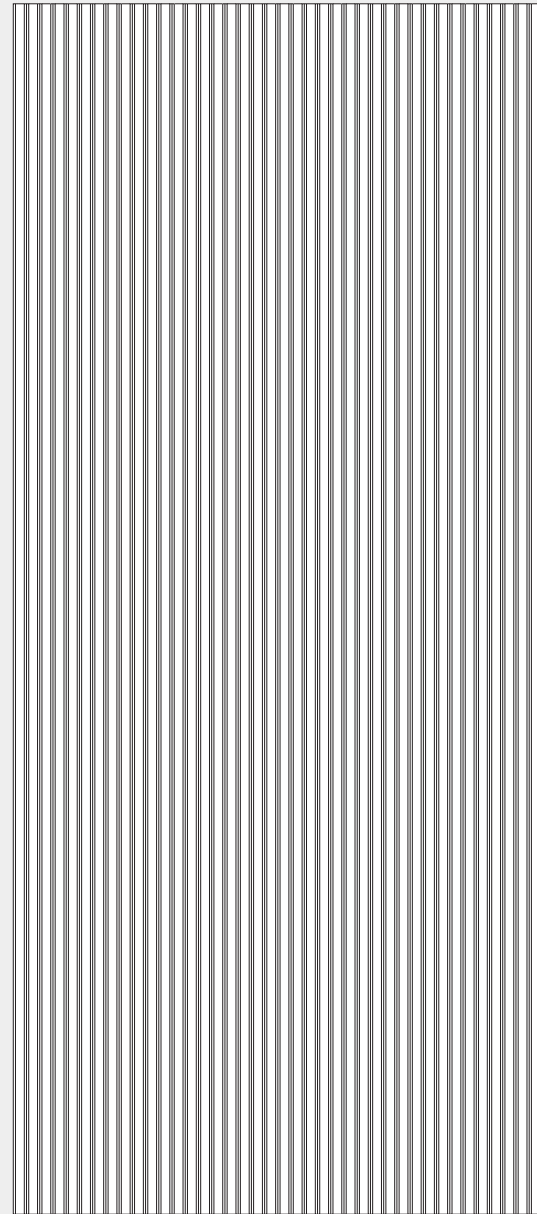

Groove Detail

30 mm  
(1.2 in)



Groovy Wide

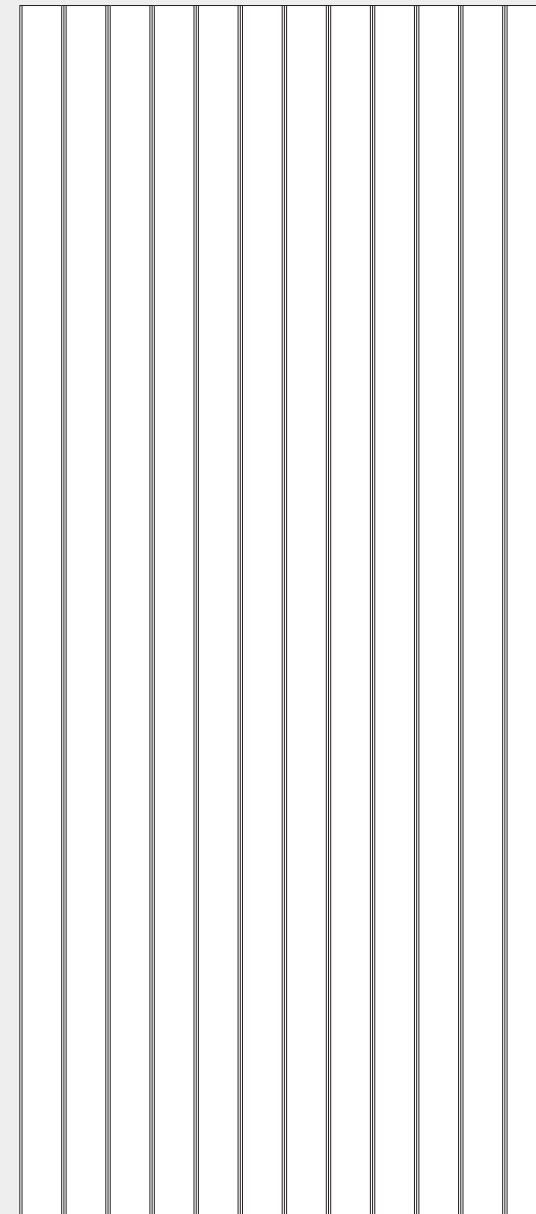

Groove Detail

100 mm  
(3.9 in)

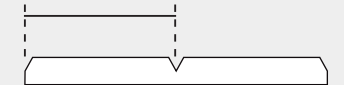

---

## Customization

Spacing between grooves can be customized to your liking.

# Standard Colours

Choose from any one of our standard colours.



**Pure White**  
SP 07



**Urban Grey**  
SP 79



**Pumice**  
SP 11



**Warm Grey**  
SP 76



**Cool Grey**  
SP 36

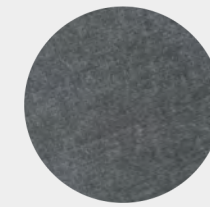

**Mid Grey**  
SP 37

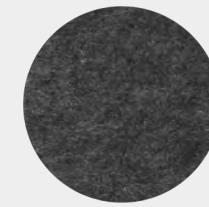

**Graphite**  
SP 03



**Black**  
SP 13



**Ivory**  
SP 77



**Beige**  
SP 04



**Sandstone**  
SP 12



**Taupe Grey\***  
SP 90

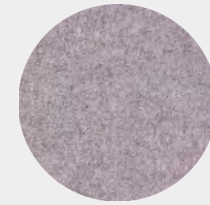

**Castlerock\***  
SP 80

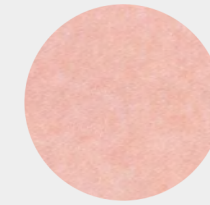

**Blush Pink**  
SP 81



**Plum**  
SP 72

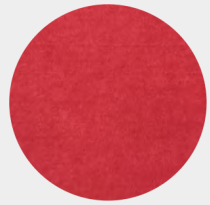

**Red**  
SP 08

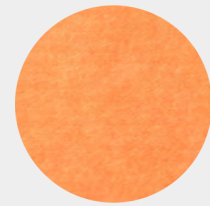

**Orange**  
SP 46

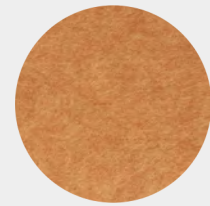

**Yam**  
SP 28

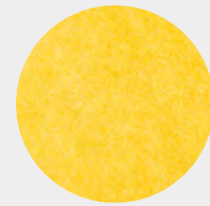

**Sunflower**  
SP 05

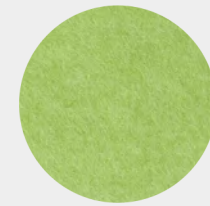

**Chartreuse**  
SP 43



**Desert Sage**  
SP 78

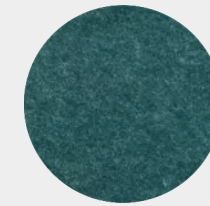

**Peacock\***  
SP 82



**Mustard\***  
SP 87



**Olive\***  
SP 88



**Moss\***  
SP 89



**Lagoon\***  
SP 84



**Azure\***  
SP 85



**Forest Green**  
SP 17



**Ocean Green\***  
SP 86



**Deep Sea Blue\***  
SP 83



**Krypton**  
SP 30



**Pale Teal**  
SP 74

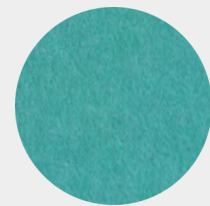

**Aquamarine**  
SP 73



**Dark Turquoise**  
SP 71

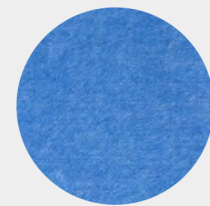

**Sky Blue**  
SP 25

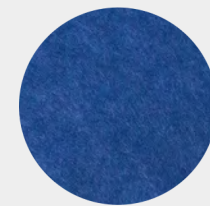

**Navy**  
SP 01



**Midnight Blue**  
SP 19



**Purple**  
SP 50

Don't see something you love? Ask us about creating your own custom colour.

All colours available in 9, 12, 18 and 24 mm unless noted otherwise.

\* 12 mm / 24 mm only

# Installation & Hardware

This is an overview of the available installation methods. Check out our installation guide for more details.

### Construction Adhesive

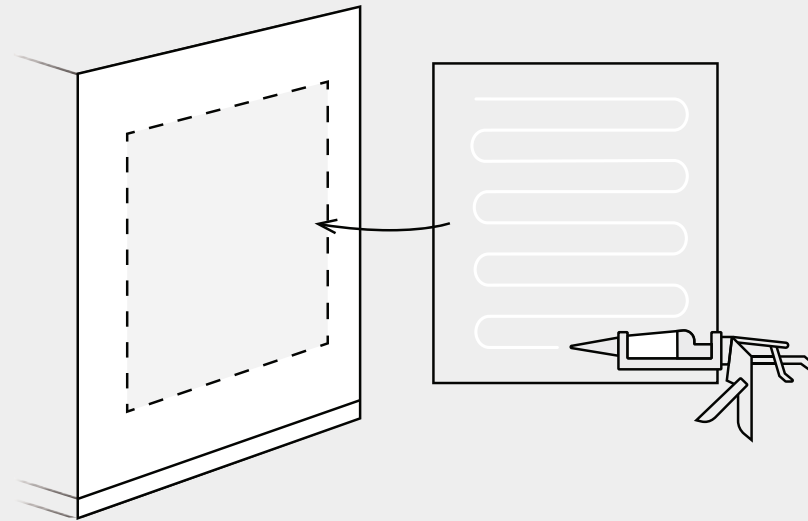

### Push Mount Clips

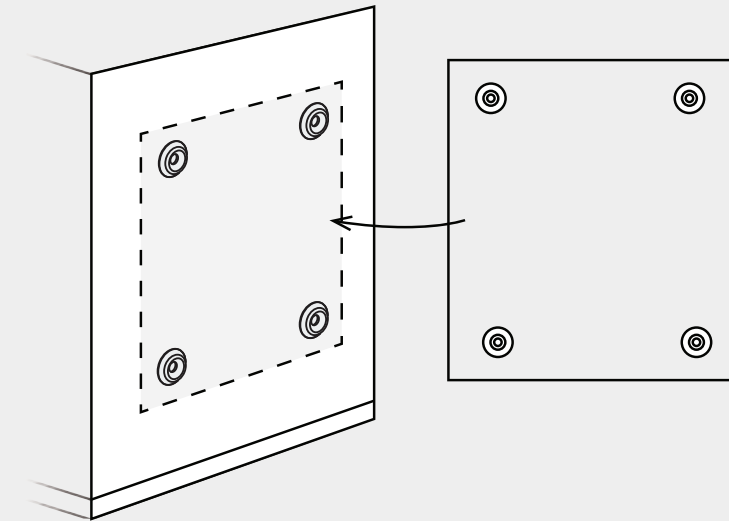

### Z-Clips

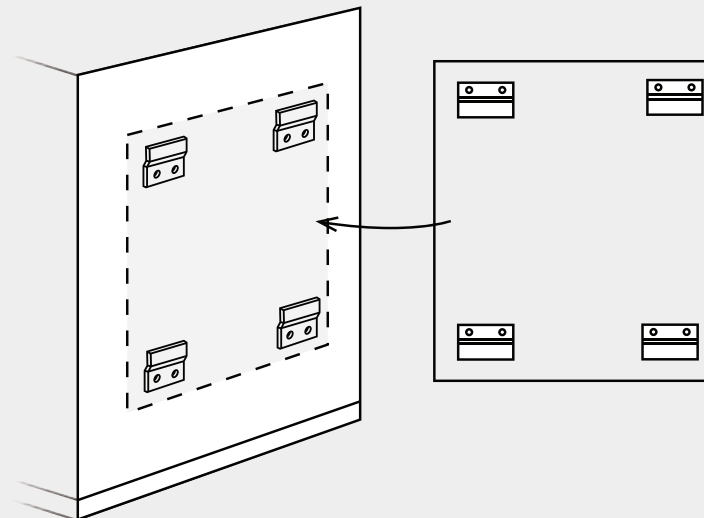

### Concealed Mechanical Fasteners

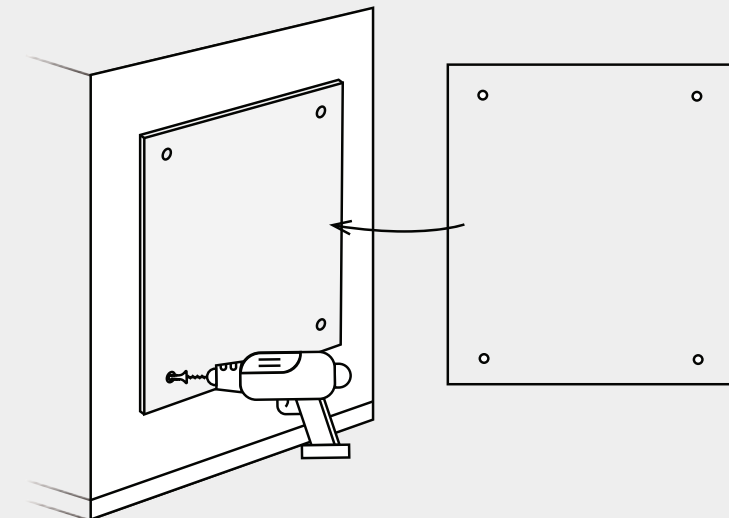

# Product Specifications

## Groovy Wall Panels

### Composition

100% polyester fibre

### VOC Emissions

CDPH (CA 01350)

### Antimicrobial Testing

Mould & mildew resistant

### Fire Rating

- ASTM E84 Class A
- CAN/ULC-S102.2-10

**Declare.**

### Sustainability

- 100% recyclable
- LBC Red List free
- Contributes to LEED certification
- Free of toxic substances and of off-gassing
- Made with ~60% recycled content from plastic water bottles

### Colour & Texture Variations

The felting and dyeing process that forms the material contributes to its unique texture but also to variations in texture and colour from panel to panel. Products will be provided within an acceptable range of variation.

# Sound Absorption Graph

The following values reflect the acoustic properties of the product as tested in accordance with ASTM C423-09a.

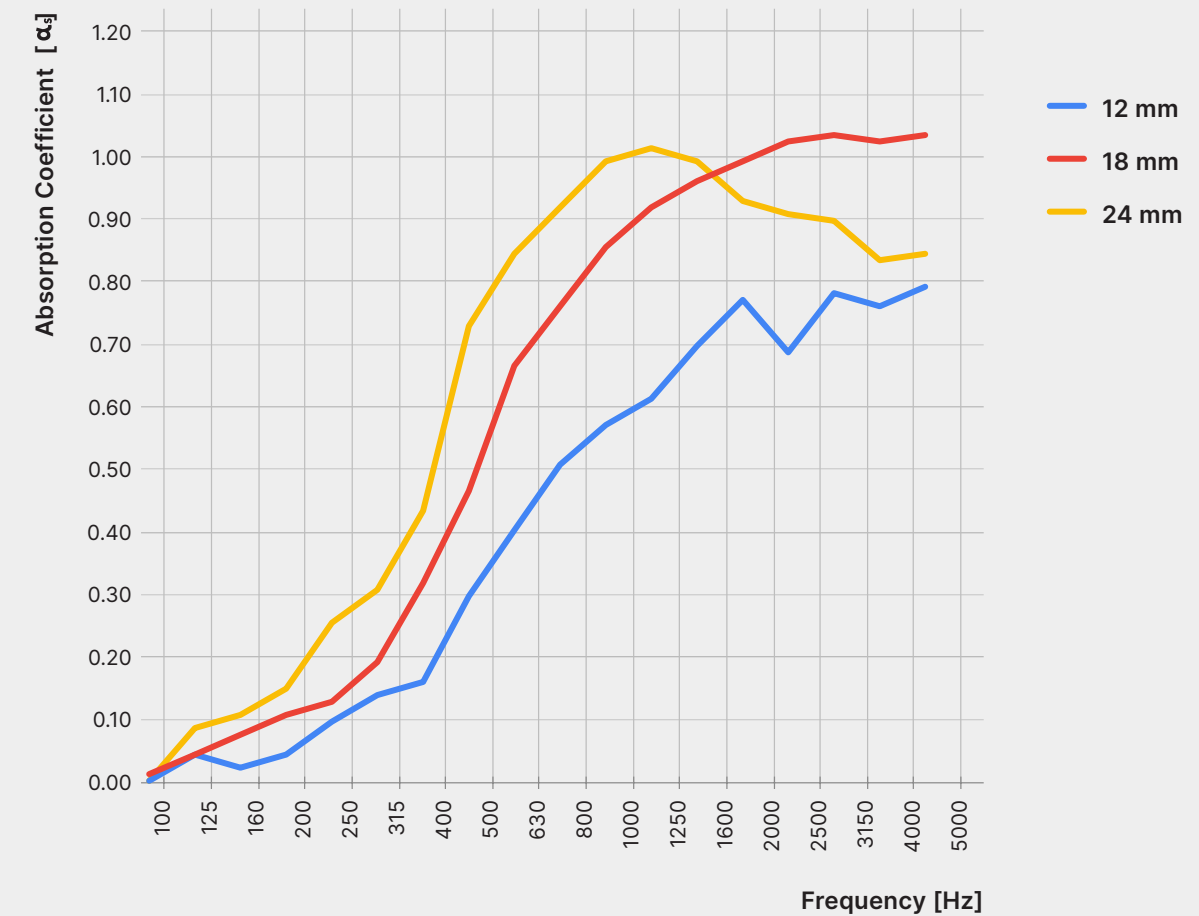

	200	250	315	400	500	630	800	1000	1250	1600	2000	2500	NRC	SAA
<b>12 mm</b>	0.04	0.09	0.13	0.15	0.28	0.38	0.48	0.54	0.58	0.66	0.73	0.65	0.40	0.39
<b>18 mm</b>	0.10	0.12	0.18	0.30	0.44	0.63	0.72	0.81	0.87	0.91	0.94	0.97	0.60	0.58
<b>24 mm</b>	0.14	0.24	0.29	0.41	0.69	0.80	0.87	0.94	0.96	0.94	0.88	0.86	0.70	0.67



# Product Care

---

## Handling & Storage

Handle products with care so as to avoid folding the polyester felt, chipping its edges or indenting its faces. Store products in their original containers in a well-ventilated area until the intended application environment is ready for installation. Allow products to acclimatize to environmental conditions. Lay them flat on their faces; do not stand them on their edges. Protect from moisture, heat, direct sunlight and the elements.

---

## Warranty

AKUSTUS warrants the construction and finish of all our products to be free from defects in material and workmanship for a period of 1 year from the date of purchase.

