

Modelo Lines Panels

BY AKUSTUS DESIGNS

AKUSTUS

®

AKUSTUS.COM

INFO@AKUSTUS.COM



GLT-WP-122-274



RAV-SC-A-122-274 & RAV-SC-B-122-274

Modelo Lines features a myriad of patterns cut as grooves onto the surface of a panel. Ranging from the intricate linework of Glint to the organic furrows of Bark, this series of panels showcases how thin lines can add texture and ambience while reducing noise and distraction. Mount it to the wall or hang it from the ceiling and discover how different your space can feel.

Dimensions

1200 x 2400

Available Thicknesses:

- 12, 18, 24 mm (0.47, 0.71, 0.94 in)

xxx-WP-120-240

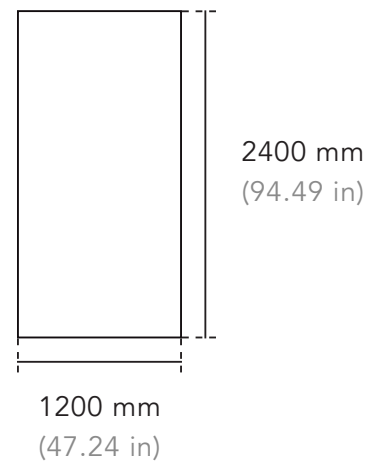

xxx-SC-120-240

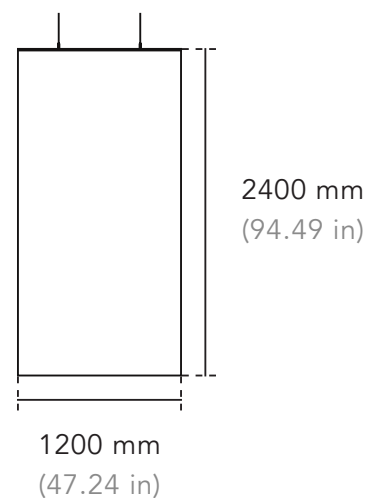

1220 x 2745

Available Thicknesses:

- 12, 24 mm (0.47, 0.94 in)

xxx-WP-122-274

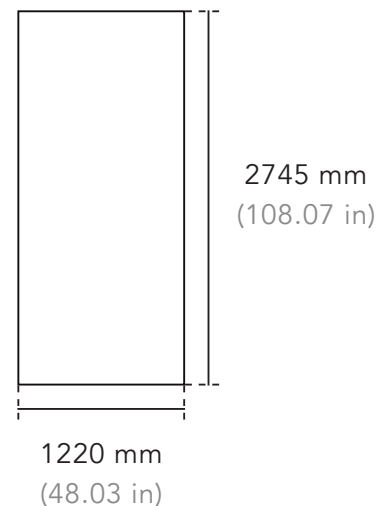

xxx-SC-122-274

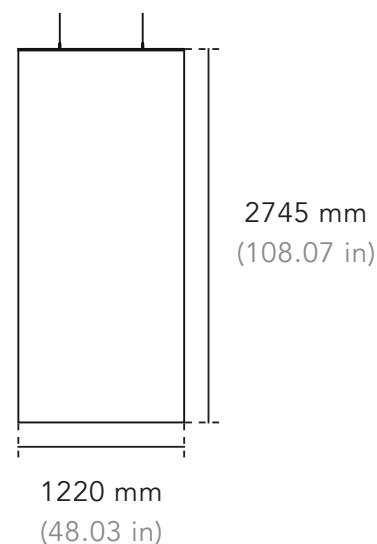

Product Data

Product Code	Width x Height	Thickness	Weight
xxx-xx-120-240	1200 x 2400 mm 47.24 x 94.49 in	12, 18, 24 mm 0.47, 0.71, 0.94 in	7.2, 11.52, 14.4 kg 15.87, 25.4, 31.75 lb
xxx-xx-122-274	1220 x 2745 mm 48.03 x 108.07 in	12, 24 mm 0.47, 0.94 in	8.37, 16.74 kg 18.45, 36.91 lb

Designs

* Custom pattern, shape and size available. Patterns may be reflected. By default, designs are on one side only for screens and for wall panels. Designs are available on both sides as an option for screens.

Bark

BAK-xx-120-240

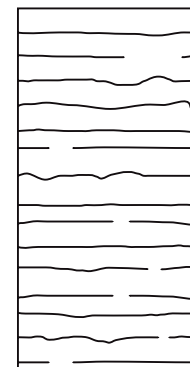

BAK-xx-122-274

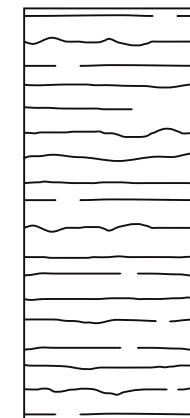

Deck

DEK-xx-120-240

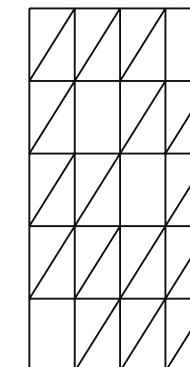

DEK-xx-122-274

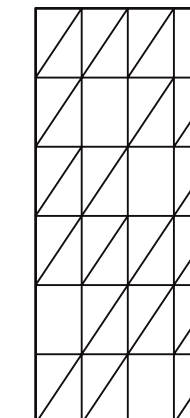

Glint

GLT-xx-120-240

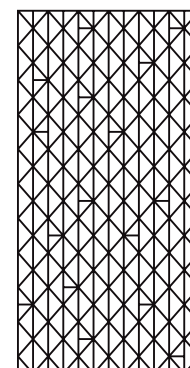

GLT-xx-122-274

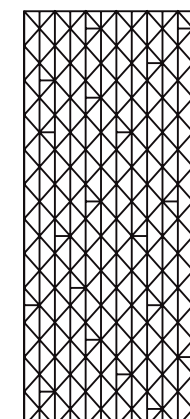

Net

NET-xx-120-240

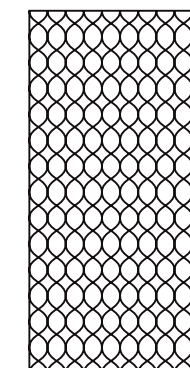

NET-xx-122-274

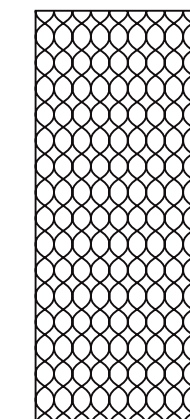

Origami

ORI-xx-120-240

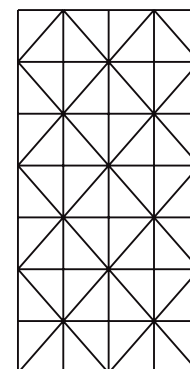

ORI-xx-122-274

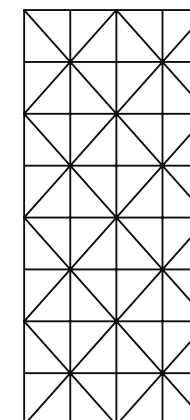

Ravine (A)

RAV-xx-A-120-240



RAV-xx-A-122-274



Designs

Ravine (B)

RAV-xx-B-120-240

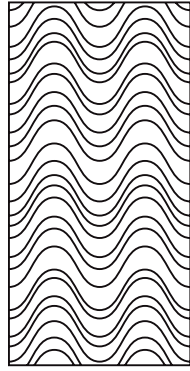

RAV-xx-B-122-274

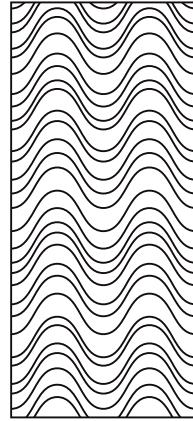

Reeds

RED-xx-120-240

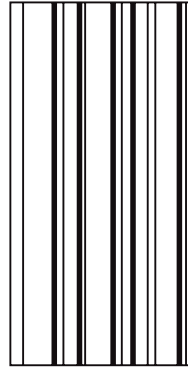

RED-xx-122-274

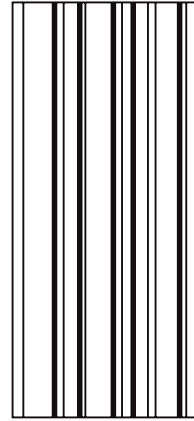

Roto

RTO-xx-120-240

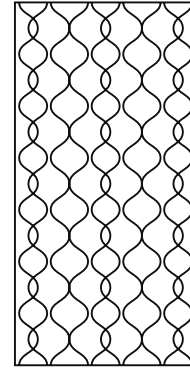

RTO-xx-122-274

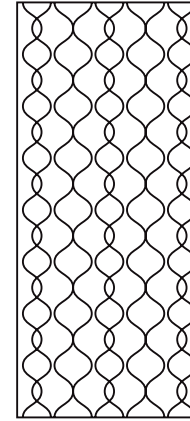

Savannah (A)

SVN-xx-A-120-240

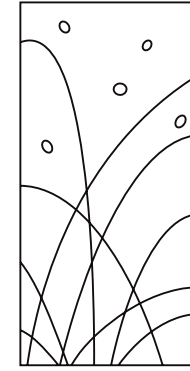

SVN-xx-A-122-274

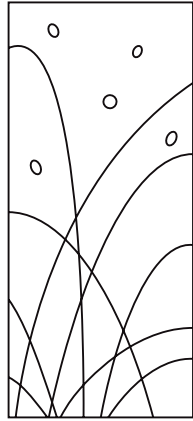

Savannah (B)

SVN-xx-B-120-240

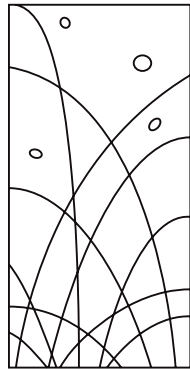

SVN-xx-B-122-274

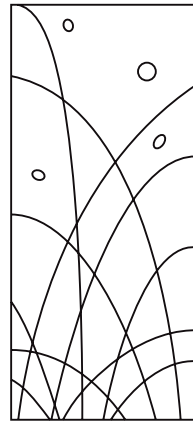

Savannah (C)

SVN-xx-C-120-240

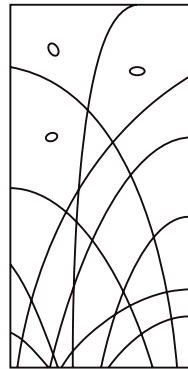

SVN-xx-C-122-274

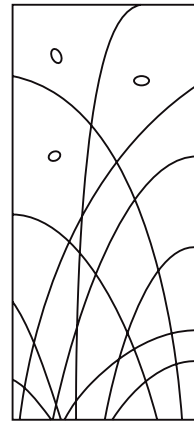

Savannah (D)

SVN-xx-D-120-240

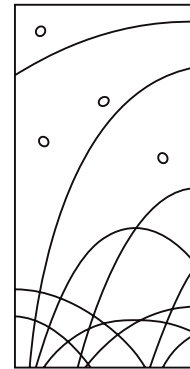

SVN-xx-D-122-274

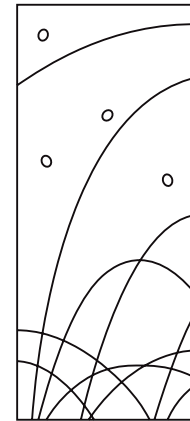

Stickwork

STK-xx-120-240

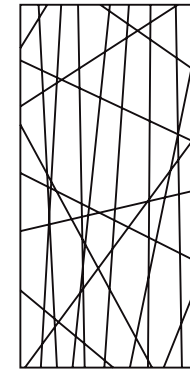

STK-xx-122-274

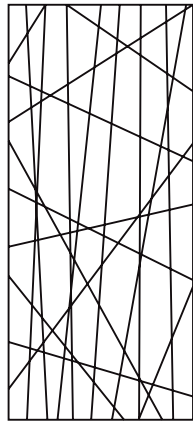

Topo

TPO-xx-120-240

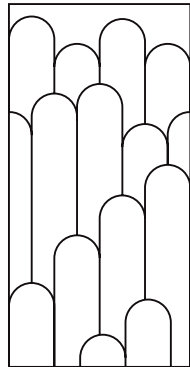

TPO-xx-122-274

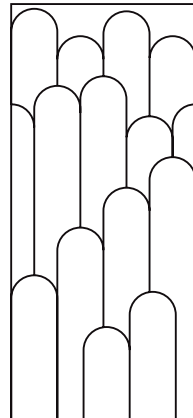

Waves

WAV-xx-120-240

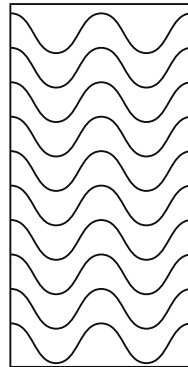

WAV-xx-122-274

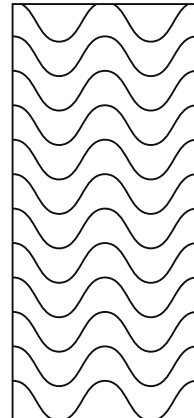

Zigzag

ZIG-xx-120-240

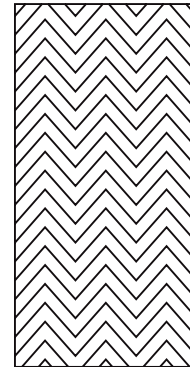

ZIG-xx-122-274

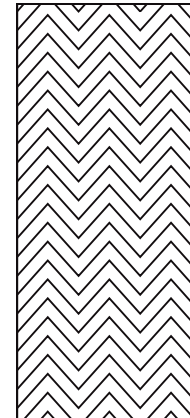

Configurations

* Examples of how the panels can be arranged ("R" indicates a reflected design)

Ravine

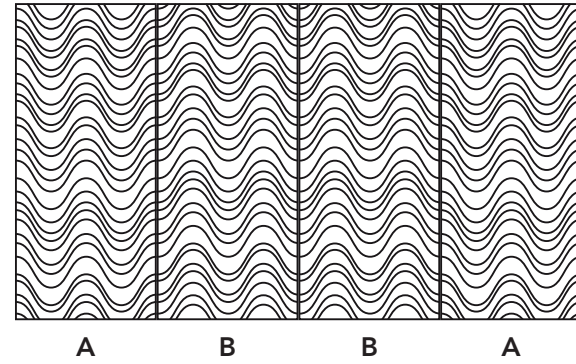
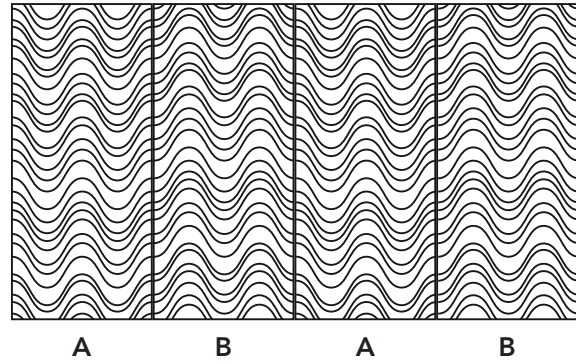

Savannah

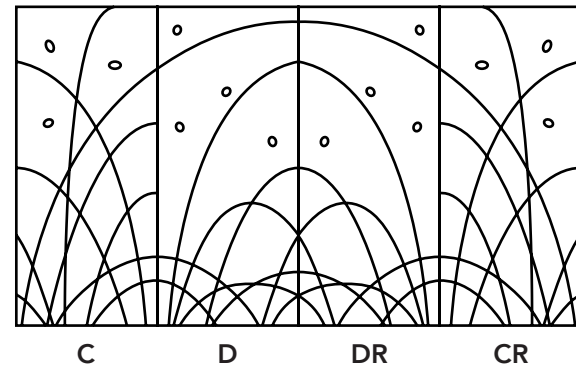
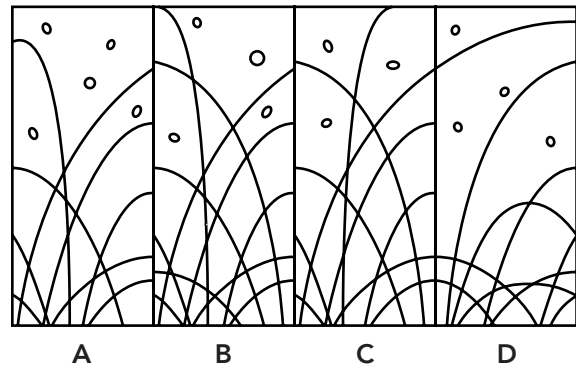

Stickwork

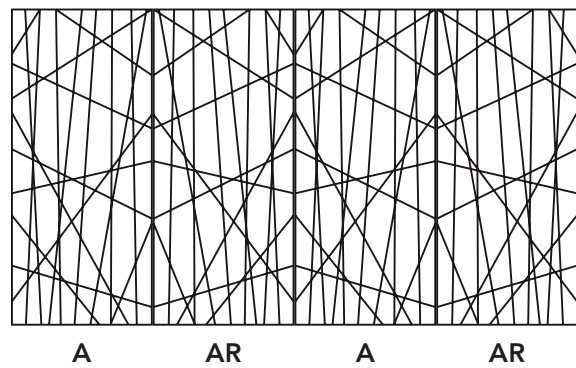

Specifications

Product Name	Modelo Lines Panels
Composition	100% polyester fibre
Edge Detail	Square edge
Fire Rating	<ul style="list-style-type: none"> • ASTM E84 Class A • CAN/ULC-S102.2-10
VOC Emissions	CDPH (CA 01350)
Antimicrobial Testing	Mould & mildew resistant
Sustainability	<ul style="list-style-type: none"> • 100% recyclable • LBC Red List free • Contributes to LEED certification • Free of toxic substances and of off-gassing • Made with ~60% recycled content from plastic water bottles

- How to Specify**
- Product Name & Code
 - Dimensions
 - Colour
 - Installation Method

Colour & Texture Variations

The felting and dyeing process that forms the material contributes to its unique texture but also to variations in texture and colour from panel to panel. Products will be provided within an acceptable range of variation.



Acoustic Properties

The following values reflect the acoustic properties of the product as tested in accordance with ASTM C423-09a using Type A and D-50 mounting.

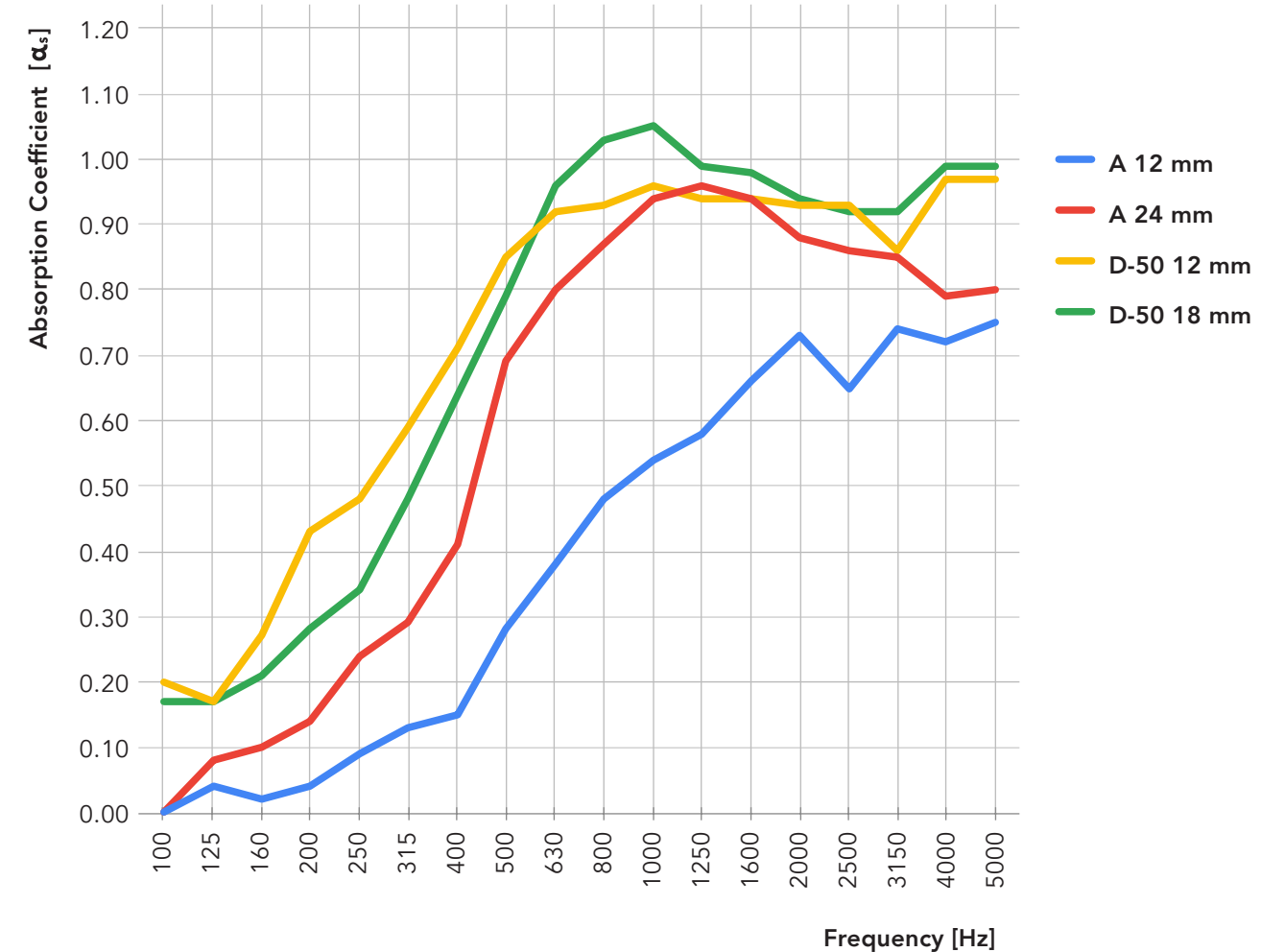

	NRC	SAA	200	250	315	400	500	630	800	1000	1250	1600	2000	2500
A 12 mm	0.40	0.39	0.04	0.09	0.13	0.15	0.28	0.38	0.48	0.54	0.58	0.66	0.73	0.65
A 24 mm	0.70	0.67	0.14	0.24	0.29	0.41	0.69	0.80	0.87	0.94	0.96	0.94	0.88	0.86
D-50 12 mm	0.80	0.80	0.43	0.48	0.59	0.71	0.85	0.92	0.93	0.96	0.94	0.94	0.93	0.93
D-50 18 mm	0.80	0.78	0.28	0.34	0.48	0.64	0.79	0.96	1.03	1.05	0.99	0.98	0.94	0.92

Wall Panel Installation

Specify one of the following options at the time of ordering.

Construction Adhesive

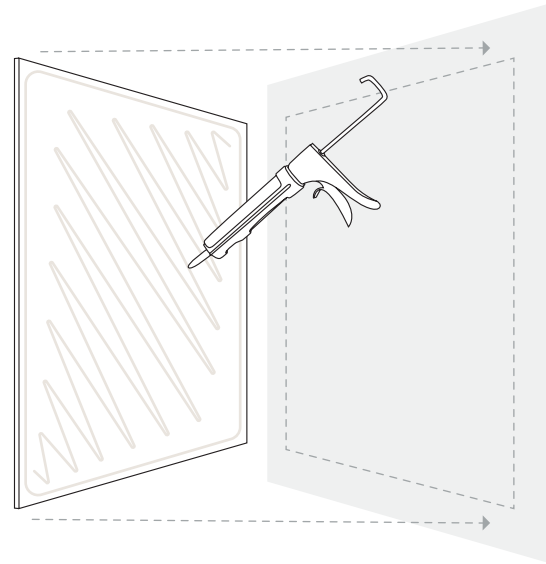
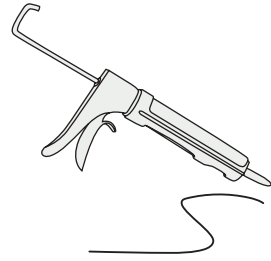

- By others
- Recommendation
- Liquid Nails Heavy Duty (Low VOC) LN-903
- Alternatives
- LePage PL Premium
 - LePage PL Premium Max
 - LePage No More Nails Heavy Duty
 - LePage No More Nails Ultimate Crystal Clear
 - (At your discretion, other construction adhesive may be used but should be tested for effectiveness)

Z-clips (KT-ZCLP-00)

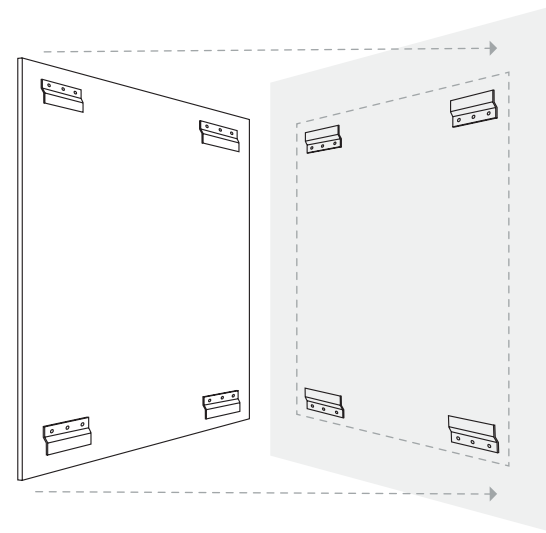
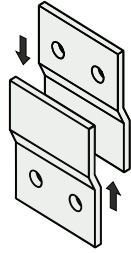

- 6 mm (1/4 in) projection from the wall
- 25 mm (1 in) clearance required above the panel

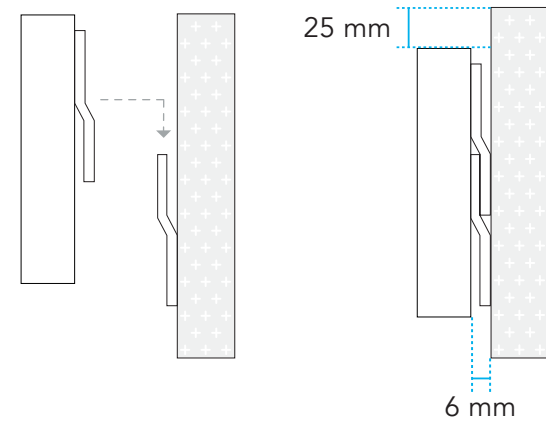

Push Mounts (KT-PUSH-00)

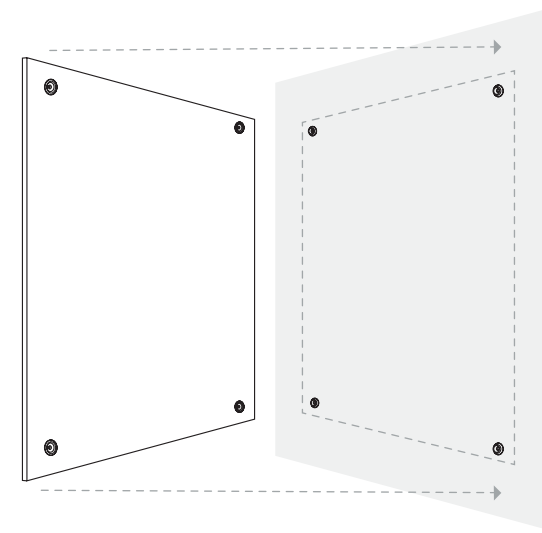
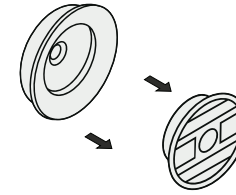

- Panels come with mounts pre-installed but receiving mount must be installed on-site

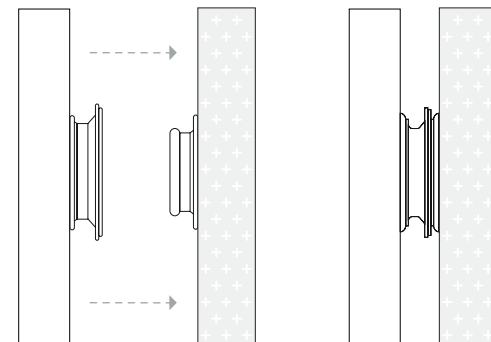

Concealed Mechanical Fasteners (KT-CCAP-00)

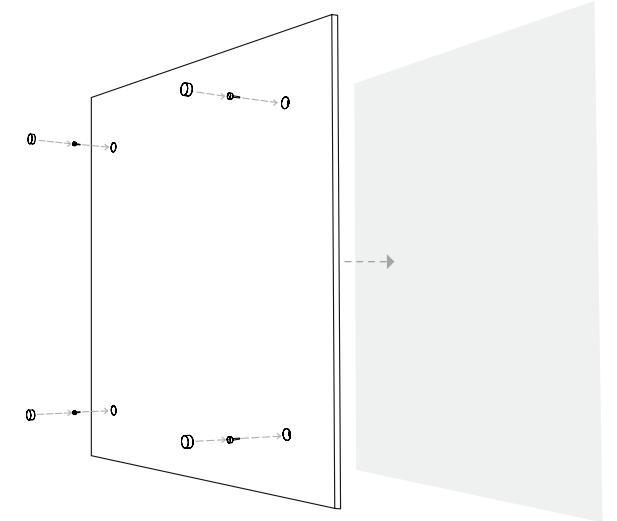
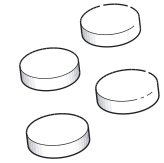

- Concealer Caps
- Provided in matching colour & material as panel
- Mechanical Fasteners
- By others
 - Optional: construction adhesive can be applied for more robust & permanent installation

Screen Installation - Aluminum Trim Kit (KT-TRIM-00)

Specify optional ceiling and accessory hardware at the time of ordering.

Ceiling Hardware Options

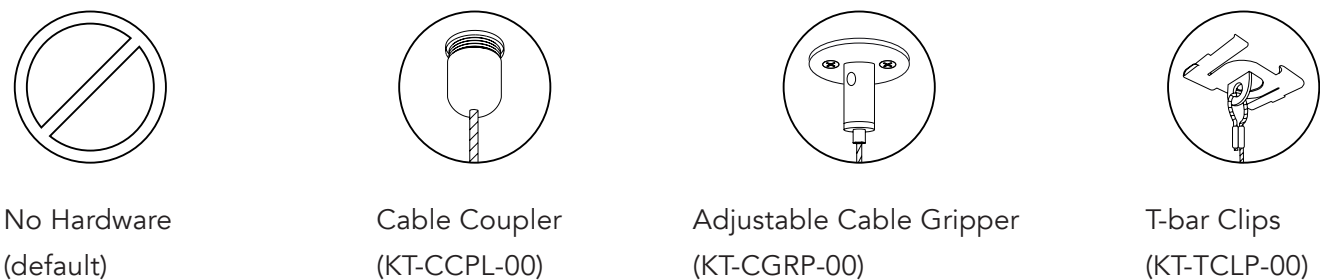

No Hardware
(default)

Cable Coupler
(KT-CCPL-00)

Adjustable Cable Gripper
(KT-CGRP-00)

T-bar Clips
(KT-TCLP-00)

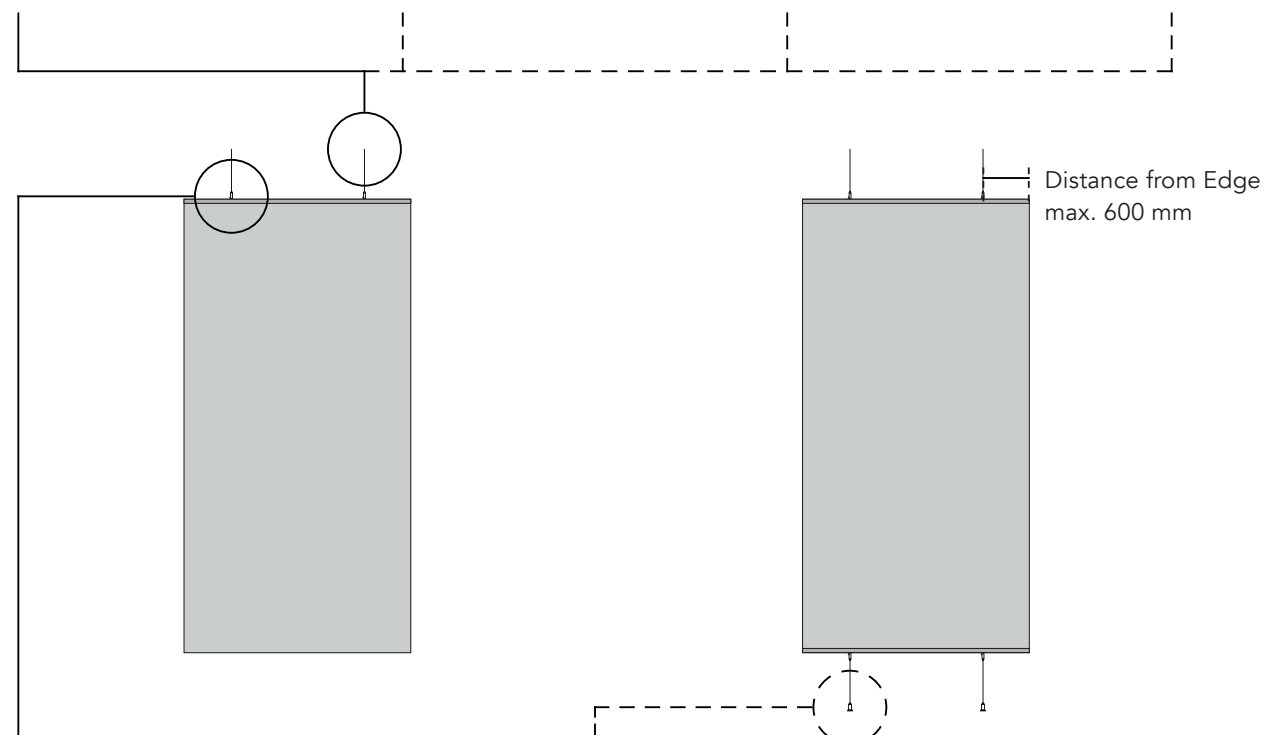

Product Hardware

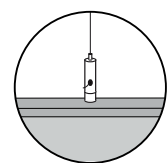

- Aluminum Trim with Adjustable Cable Gripper
- Clear anodized finish (matte black available)
 - Suspension point pre-mounted but can be repositioned on site

Accessory Hardware Option

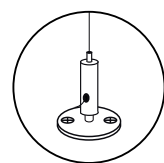

- Floor Mounted Cable Gripper (HW-FGRP-00)

Screen Installation - Sliding Track Kit (KT-SLID-00)

Specify optional accessory hardware at the time of ordering.

Single Row

Track Layout

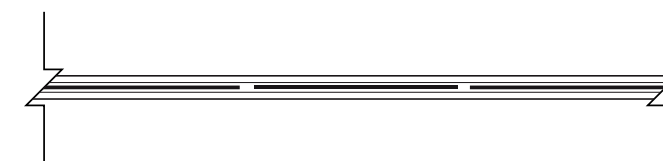

Multiple Rows

Track Layout

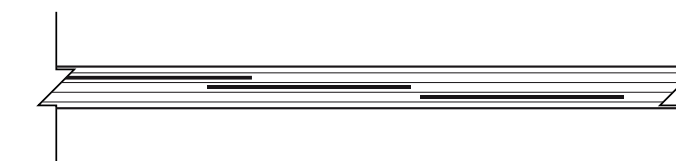

- May be layered in as many rows as desired

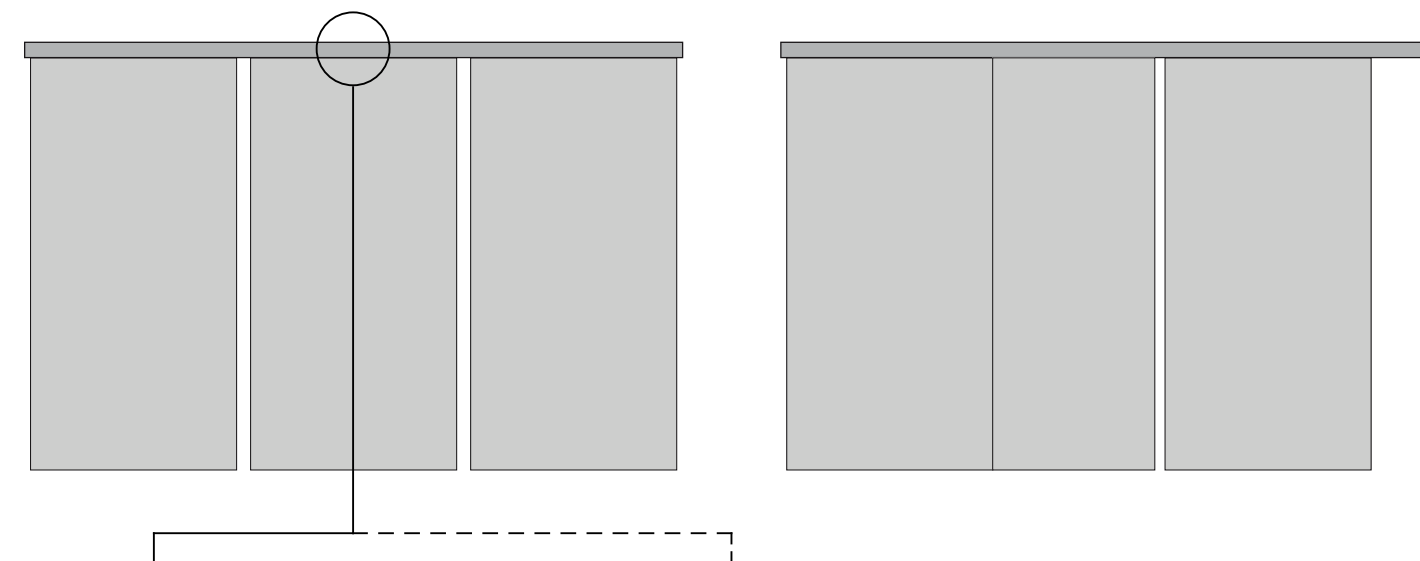

Product Hardware

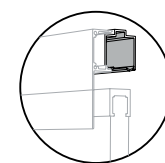

- Sliding Track
- Mill finish
 - Must be mounted to flat, stable & sturdy surface (install blocking if needed)
 - Adds 54-60 mm to the panel height

Accessory Hardware Option

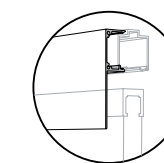

- Track Fascia (HW-FASC-00)
- Clear anodized finish
 - Hides the internals of the track system
 - Clips into place

Product Care

Handling & Storage

Handle products with care so as to avoid folding the polyester felt, chipping its edges or indenting its faces. Store products in their original containers in a well-ventilated area until the intended application environment is ready for installation. Allow products to acclimatize to environmental conditions. Lay them flat on their faces; do not stand them on their edges. Protect from moisture, heat, direct sunlight and the elements.

Maintenance

Lightly brush or gently vacuum to remove dust from polyester felt. Clean with warm water and mild, non-toxic soap to remove spills. Test solution on an inconspicuous spot before applying to more visible areas. Blot with a dry cloth after applying the solution to avoid saturating the material. Avoid applying too much pressure when cleaning the products.

Warranty

AKUSTUS warrants the construction and finish of all our products to be free from defects in material and workmanship for a period of 1 year from the date of purchase.

Colours

* 12/24 mm only



Pure White
SP 07



Urban Grey
SP 79

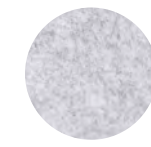

Pumice
SP 11

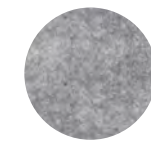

Cool Grey
SP 36

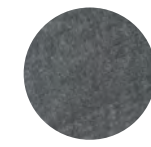

Mid Grey
SP 37



Black
SP 13



Ivory
SP 77



Beige
SP 04



Sandstone
SP 12



Taupe Grey *
SP 90



Warm Grey
SP 76

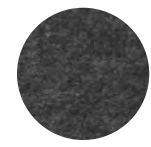

Graphite
SP 03

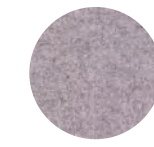

Castlerock *
SP 80



Blush Pink
SP 81



Plum
SP 72

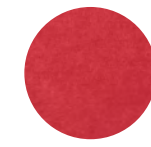

Red
SP 08

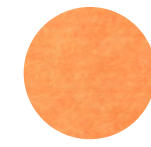

Orange
SP 46



Yam
SP 28



Mustard *
SP 87

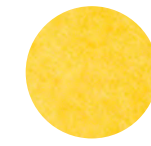

Sunflower
SP 05



Chartreuse
SP 43

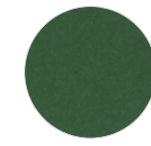

Moss *
SP 89

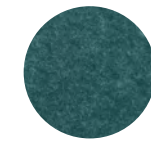

Peacock *
SP 82



Olive *
SP 88



Ocean Green *
SP 86

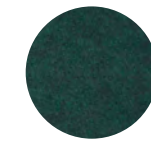

Forest Green
SP 17

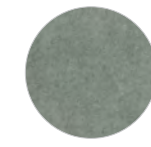

Desert Sage
SP 78



Deep Sea Blue *
SP 83



Krypton
SP 30

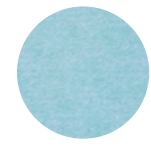

Pale Teal
SP 74



Lagoon *
SP 84

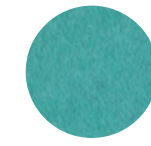

Aquamarine
SP 73

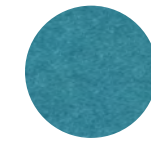

Dark Turquoise
SP 71



Azure *
SP 85

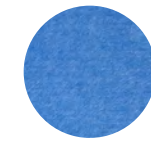

Sky Blue
SP 25



Navy
SP 01

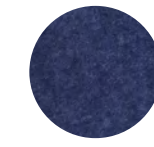

Midnight Blue
SP 19



Purple
SP 50