



Valley Baffle

BY AKUSTUS DESIGNS





VAL-BF-A-033-240

The dips and slopes of **Valley Baffle** create fascinating visuals from no matter which angle you view them from. While the panel material absorbs excess sound energy, the slanted faces of the baffle cause sound waves to reflect and diffuse more evenly within the room. Let Valley help you create a room that's wonderful to be in and to look at.

Dimensions - Individual Baffles

* Custom shape and size available.

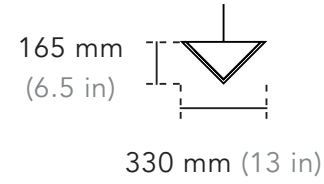

VAL-BF-A-033-072

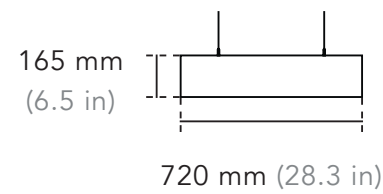

VAL-BF-A-033-114

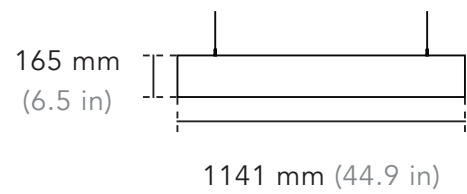

VAL-BF-A-033-161

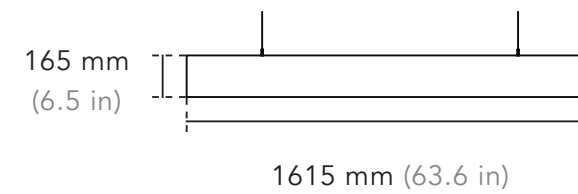

VAL-BF-A-033-082

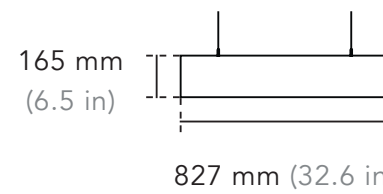

VAL-BF-A-033-129

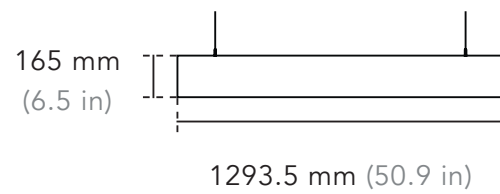

VAL-BF-A-033-171

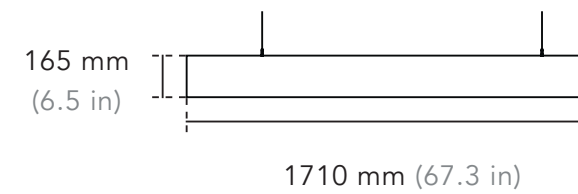

VAL-BF-A-033-087

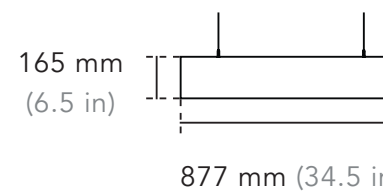

VAL-BF-A-033-145

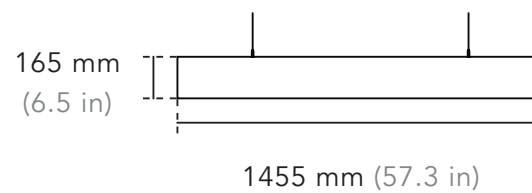

VAL-BF-A-033-244

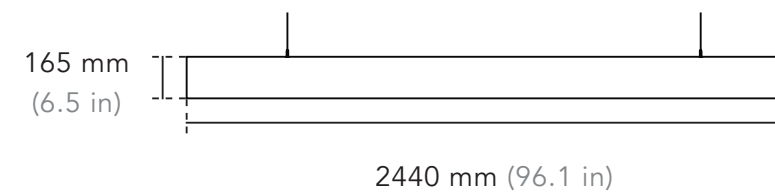

VAL-BF-A-033-097

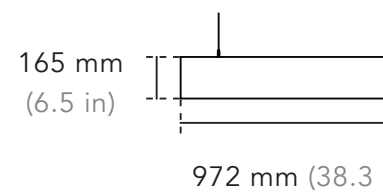

VAL-BF-A-033-156

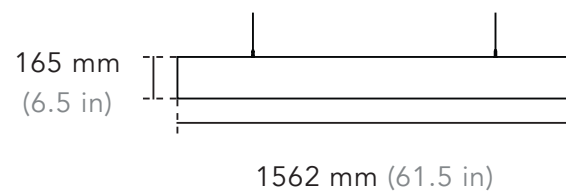

VAL-BF-A-033-274

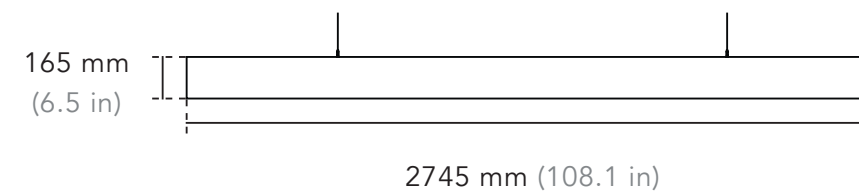

Product Data

Product Code	Width x Length	Height	Weight
VAL-BF-A-033-072	330 x 720 mm 13 x 28.3 in	165 mm 6.5 in	1.2 kg 2.6 lb
VAL-BF-A-033-082	330 x 827 mm 13 x 32.6 in	165 mm 6.5 in	1.3 kg 2.9 lb
VAL-BF-A-033-087	330 x 877 mm 13 x 34.5 in	165 mm 6.5 in	1.3 kg 2.9 lb
VAL-BF-A-033-097	330 x 972 mm 13 x 38.3 in	165 mm 6.5 in	1.4 kg 3.1 lb
VAL-BF-A-033-114	330 x 1141 mm 13 x 44.9 in	165 mm 6.5 in	1.6 kg 3.5 lb
VAL-BF-A-033-129	330 x 1293.5 mm 13 x 50.9 in	165 mm 6.5 in	1.8 kg 4 lb
VAL-BF-A-033-145	330 x 1455 mm 13 x 57.3 in	165 mm 6.5 in	2 kg 4.4 lb
VAL-BF-A-033-156	330 x 1562 mm 13 x 61.5 in	165 mm 6.5 in	2.1 kg 4.6 lb
VAL-BF-A-033-161	330 x 1615 mm 13 x 63.6 in	165 mm 6.5 in	2.2 kg 4.9 lb
VAL-BF-A-033-171	330 x 1710 mm 13 x 67.3 in	165 mm 6.5 in	2.3 kg 5.1 lb
VAL-BF-A-033-244	330 x 2440 mm 13 x 96.1 in	165 mm 6.5 in	3.2 kg 7.1 lb
VAL-BF-A-033-274	330 x 2745 mm 13 x 108.1 in	165 mm 6.5 in	3.5 kg 7.7 lb

Dimensions - Baffle Cloud

* Custom shape and size available.

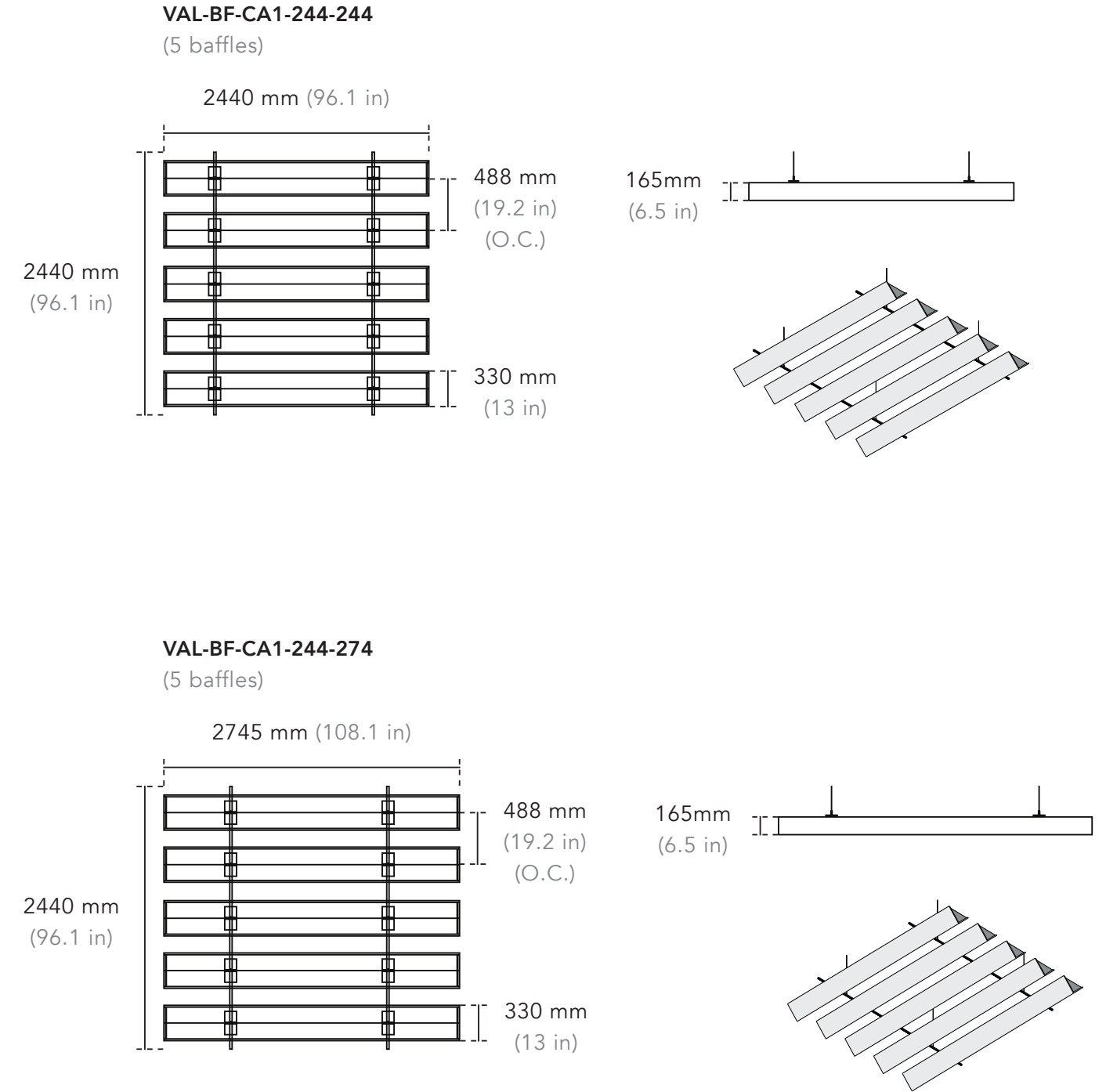

Dimensions - Baffle Cloud

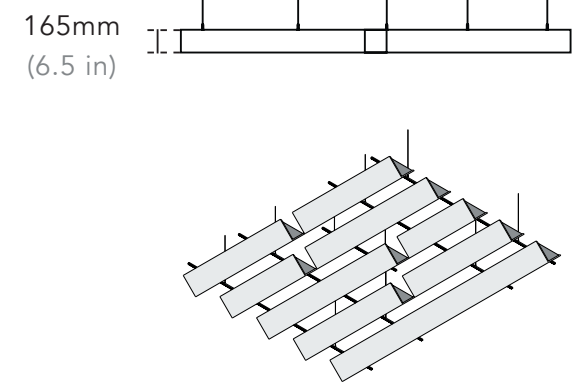
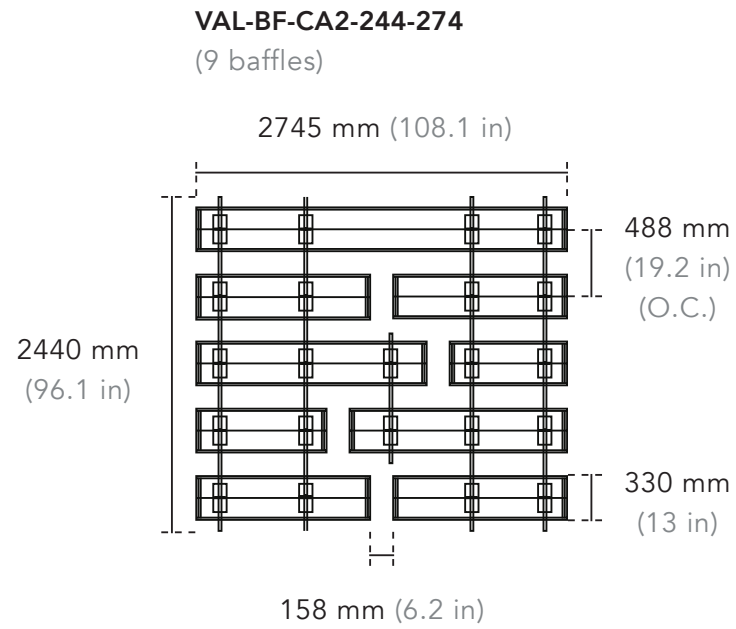
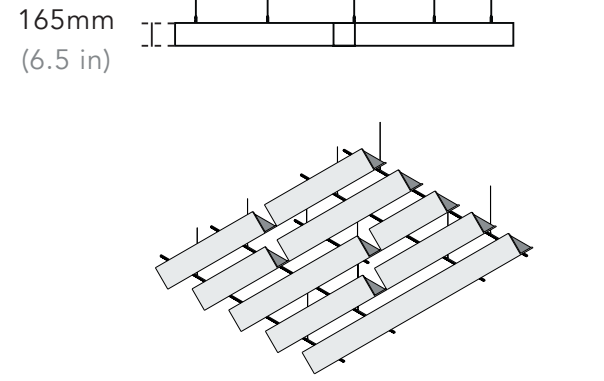
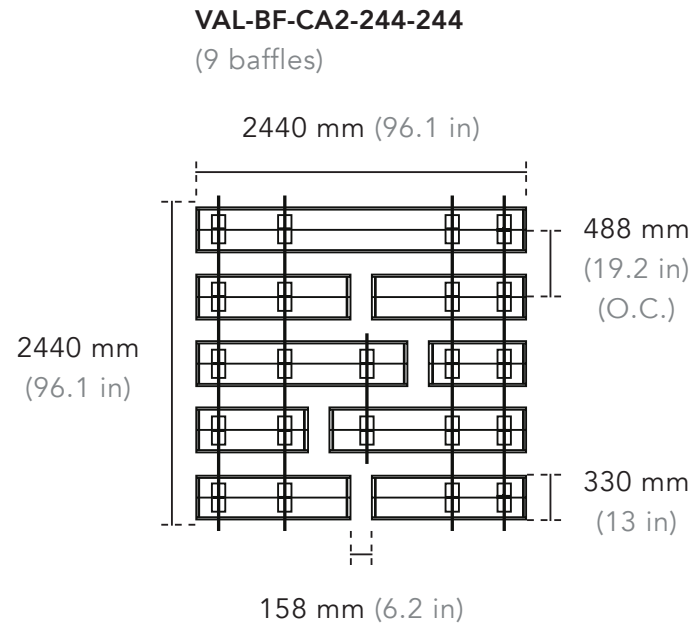

Product Data

Product Code	Width x Length x Height	Spacing	Baffle Width	Weight
VAL-BF-CA1-244-244	2440 x 2440 x 165 mm 96.1 x 96.1 x 6.5 in	488 mm 19.2 in	330 mm 13 in	17.5 kg 38.6 lb
VAL-BF-CA1-244-274	2440 x 2745 x 165 mm 96.1 x 108.1 x 6.5 in	488 mm 19.2 in	330 mm 13 in	19 kg 41.9 lb
VAL-BF-CA2-244-244	2440 x 2440 x 165 mm 96.1 x 96.1 x 6.5 in	488 mm 19.2 in	330 mm 13 in	16 kg 35.3 lb
VAL-BF-CA2-244-274	2440 x 2745 x 165 mm 96.1 x 108.1 x 6.5 in	488 mm 19.2 in	330 mm 13 in	17.4 kg 38.4 lb

Specifications

Product Name	Valley Baffle
Composition	100% polyester fibre
Fire Rating	<ul style="list-style-type: none"> • ASTM E84 Class A • CAN/ULC-S102.2-10
VOC Emissions	CDPH (CA 01350)
Antimicrobial Testing	Mould & mildew resistant
Sustainability	<ul style="list-style-type: none"> • 100% recyclable • LBC Red List free • Contributes to LEED certification • Free of toxic substances and of off-gassing • Made with ~60% recycled content from plastic water bottles

- How to Specify**
- Product Name & Code
 - Dimensions
 - Colour
 - Installation Method

Colour & Texture Variations

The felting and dyeing process that forms the material contributes to its unique texture but also to variations in texture and colour from panel to panel. Products will be provided within an acceptable range of variation.



Acoustic Properties

The following values reflect the acoustic properties of the product as tested in accordance with ASTM C423-09a using Type J mounting.

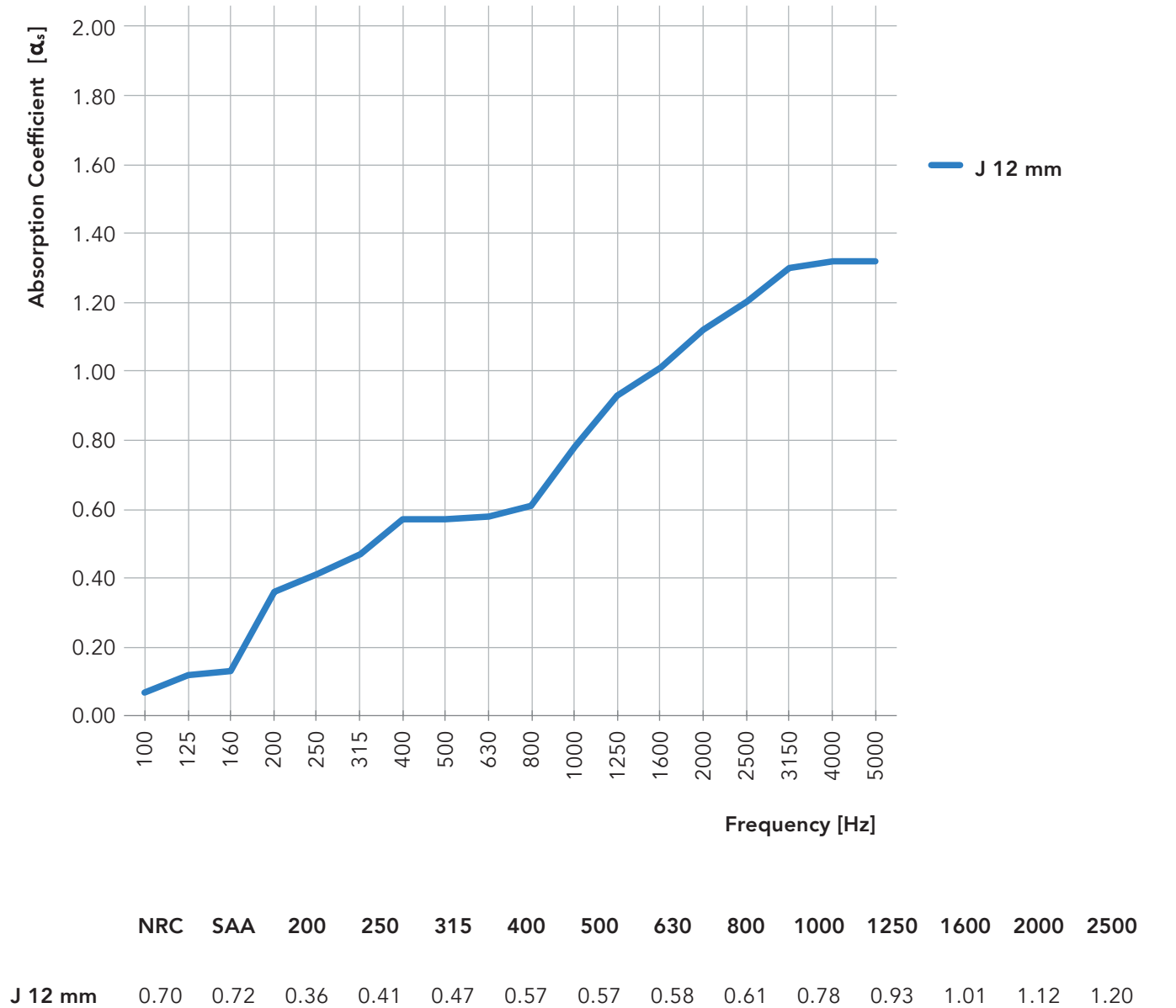

Installation - Valley Baffle Kit (KT-VABF-00)

Specify optional ceiling hardware at the time of ordering.

Ceiling Hardware Options

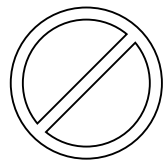

No Hardware
(default)

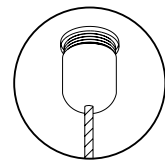

Cable Coupler
(KT-CCPL-00)

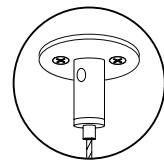

Adjustable Cable Gripper
(KT-CGRP-00)

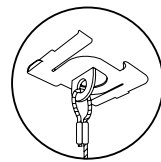

T-bar Clips
(KT-TCLP-00)

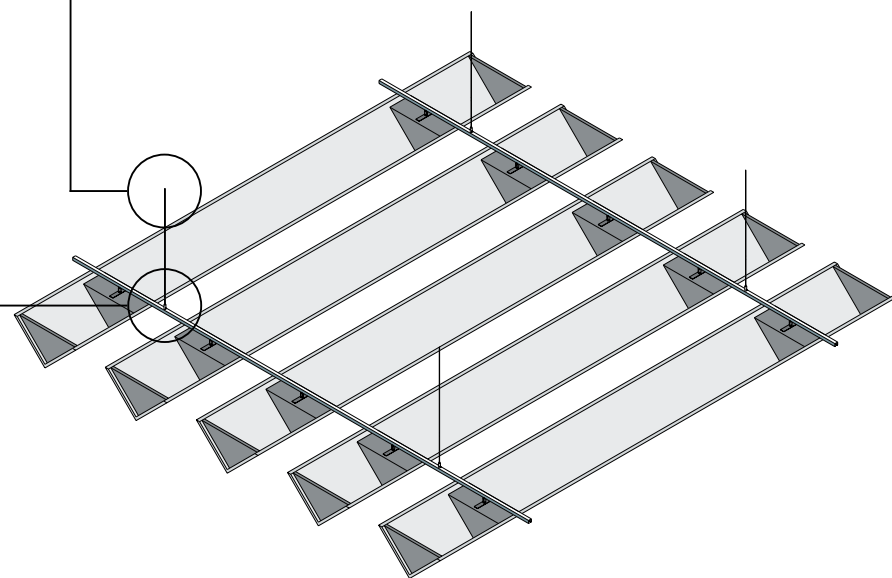

Product Hardware

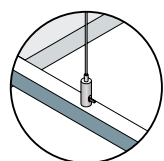

Aluminum Channel with
Adjustable Cable Gripper

- Clear anodized finish
(matte black available)
- Suspension point pre-mounted but can be repositioned on site

Product Care

Handling & Storage

Handle products with care so as to avoid folding the polyester felt, chipping its edges or indenting its faces. Store products in their original containers in a well-ventilated area until the intended application environment is ready for installation. Allow products to acclimatize to environmental conditions. Lay them flat on their faces; do not stand them on their edges. Protect from moisture, heat, direct sunlight and the elements.

Maintenance

Lightly brush or gently vacuum to remove dust from polyester felt. Clean with warm water and mild, non-toxic soap to remove spills. Test solution on an inconspicuous spot before applying to more visible areas. Blot with a dry cloth after applying the solution to avoid saturating the material. Avoid applying too much pressure when cleaning the products.

Warranty

AKUSTUS warrants the construction and finish of all our products to be free from defects in material and workmanship for a period of 1 year from the date of purchase.

Colours



Pure White
SP 07



Krypton
SP 30



Urban Grey
SP 79

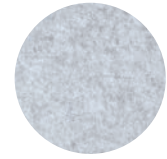

Pumice
SP 11

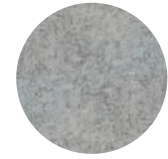

Warm Grey
SP 76

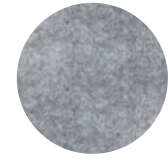

Cool Grey
SP 36

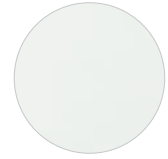

Ivory
SP 77



Beige
SP 04



NEW

Castlerock
SP 80

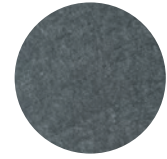

Mid Grey
SP 37

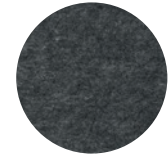

Graphite
SP 03



Black
SP 13



Sandstone
SP 12

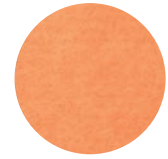

Orange
SP 46

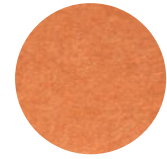

Yam
SP 28



Wild Currant
SP 48



Plum
SP 72

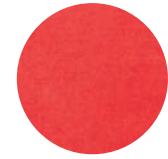

Red
SP 08

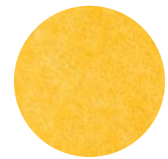

Sunflower
SP 05



Chartreuse
SP 43

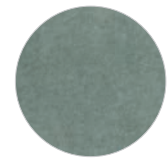

Desert Sage
SP 78

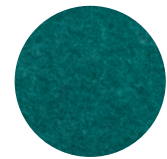

NEW

Peacock
SP 82

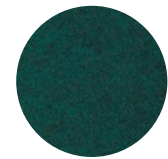

Forest Green
SP 17

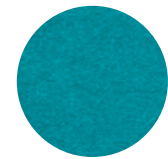

Dark Turquoise
SP 71

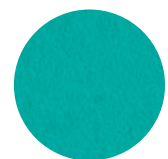

Aquamarine
SP 73



Pale Teal
SP 74

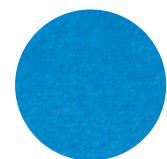

Sky Blue
SP 25

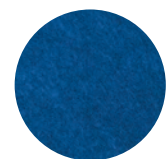

Navy
SP 01

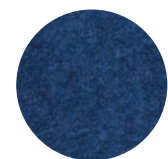

Midnight Blue
SP 19

