

Herringbone Wall Panel

BY AKUSTUS DESIGNS



AKUSTUS.COM

INFO@AKUSTUS.COM



HRB-WP-106-095

The **Herringbone Wall Panel** demonstrates how well a staple pattern of design can be translated into the form of acoustic panels. Mount these panels to decorate the wall and improve the acoustics of a lecture hall or of a boardroom.



HRB-WP-106-095

HERRINGBONE WALL PANEL



HRB-WP-W1-127-275, HRB-WP-W2-127-275 & HRB-WP-W3-095-275

HERRINGBONE WALL PANEL

Dimensions

Available Thicknesses: 12, 18, 24 mm (0.5, 0.7, 0.9 in)

* Custom shape and size available.

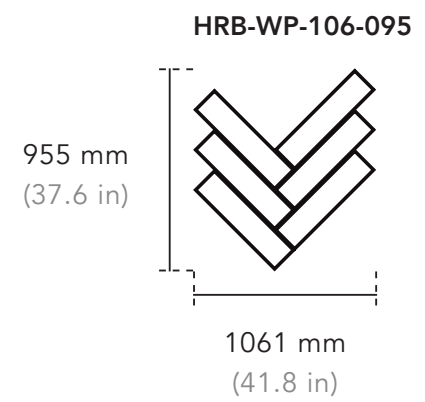
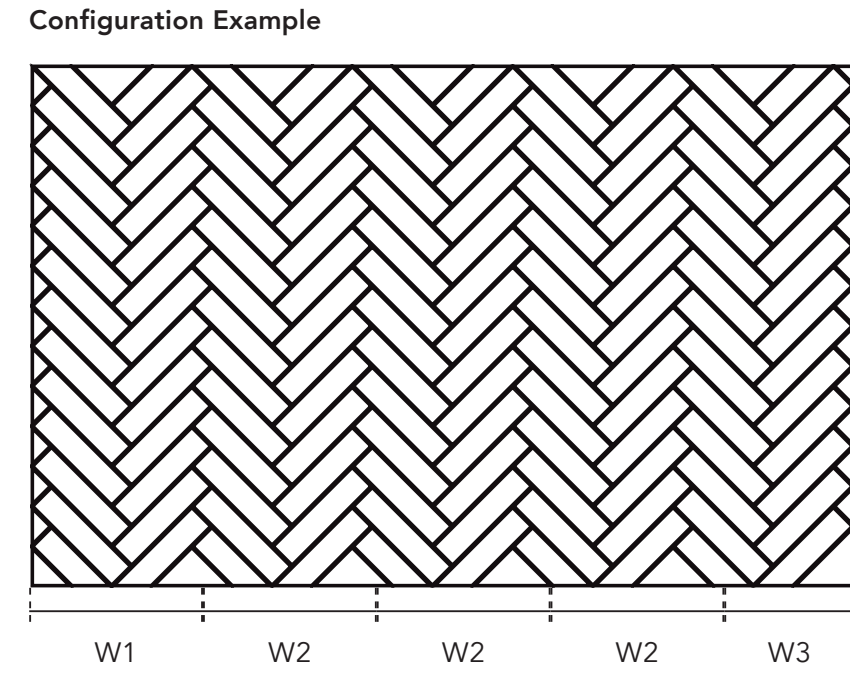
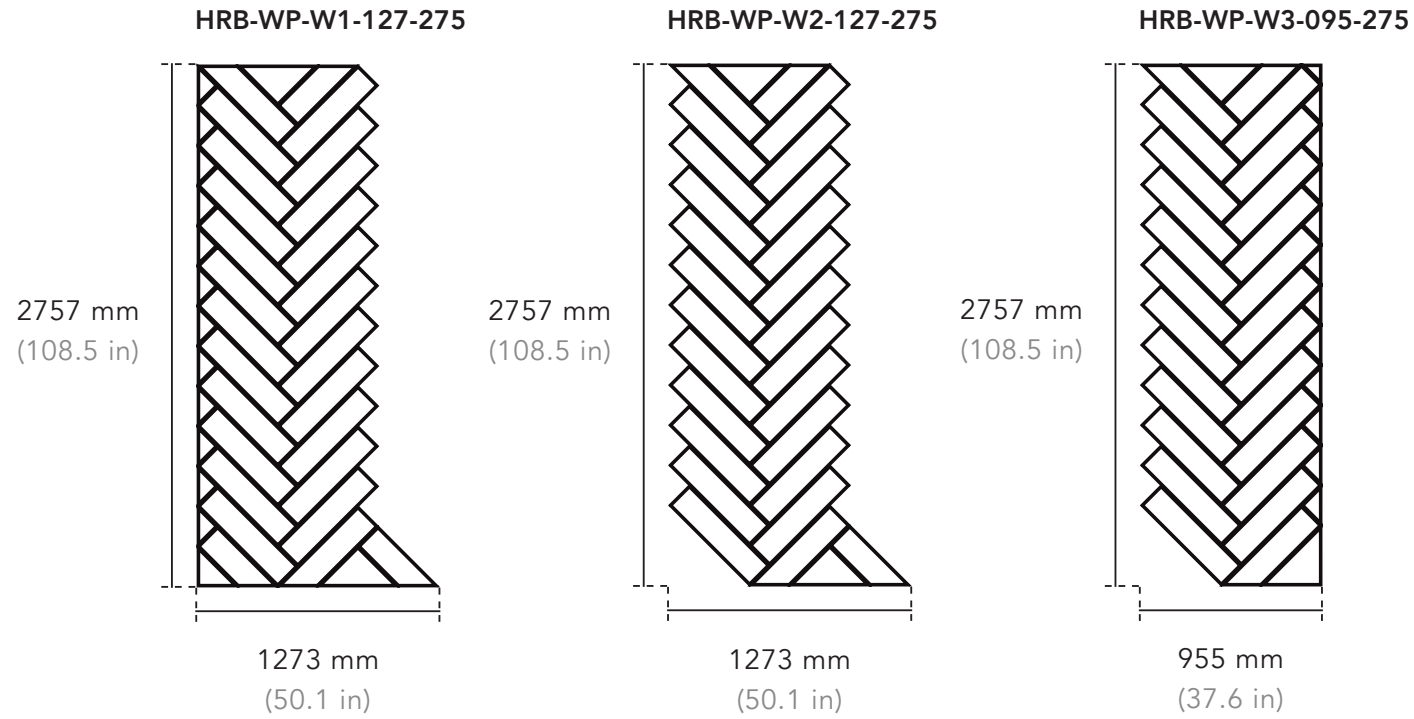

Product Data

Product Code	Width x Height	Thickness	Weight
HRB-WP-106-095	1061 x 955 mm 41.8 x 37.6 in	12, 18, 24 mm 0.5, 0.7, 0.9 in	1.4, 2.2, 2.7 kg 3.1, 4.9, 6 lb
HRB-WP-W1-127-275	1273 x 2757 mm 50.1 x 108.5 in	12, 18, 24 mm 0.5, 0.7, 0.9 in	6.4, 10.2, 12.8 kg 14.1, 22.5, 28.2 lb
HRB-WP-W2-127-275	1273 x 2757 mm 50.1 x 108.5 in	12, 18, 24 mm 0.5, 0.7, 0.9 in	5.8, 9.4, 11.7 kg 12.8, 20.7, 25.8 lb
HRB-WP-W3-095-275	955 x 2757 mm 37.6 x 108.5 in	12, 18, 24 mm 0.5, 0.7, 0.9 in	6, 9.7, 12.1 kg 13.2, 21.4, 26.7 lb

Specifications

- Product Name** Herringbone Wall Panel
- Composition** 100% polyester fibre
- Edge Detail** Chamfered edge
- Fire Rating**
 - ASTM E84 Class A
 - CAN/ULC-S102.2-10
- VOC Emissions** CDPH (CA 01350)
- Antimicrobial Testing** Mould & mildew resistant
- Sustainability**
 - 100% recyclable
 - LBC Red List free
 - Contributes to LEED certification
 - Free of toxic substances and of off-gassing
 - Made with ~60% recycled content from plastic water bottles

- How to Specify**
 - Product Name & Code
 - Dimensions
 - Colour
 - Installation Method

Colour & Texture Variations The felting and dyeing process that forms the material contributes to its unique texture but also to variations in texture and colour from panel to panel. Products will be provided within an acceptable range of variation.



Acoustic Properties

The following values reflect the acoustic properties of the product as tested in accordance with ASTM C423-09a using Type A mounting.

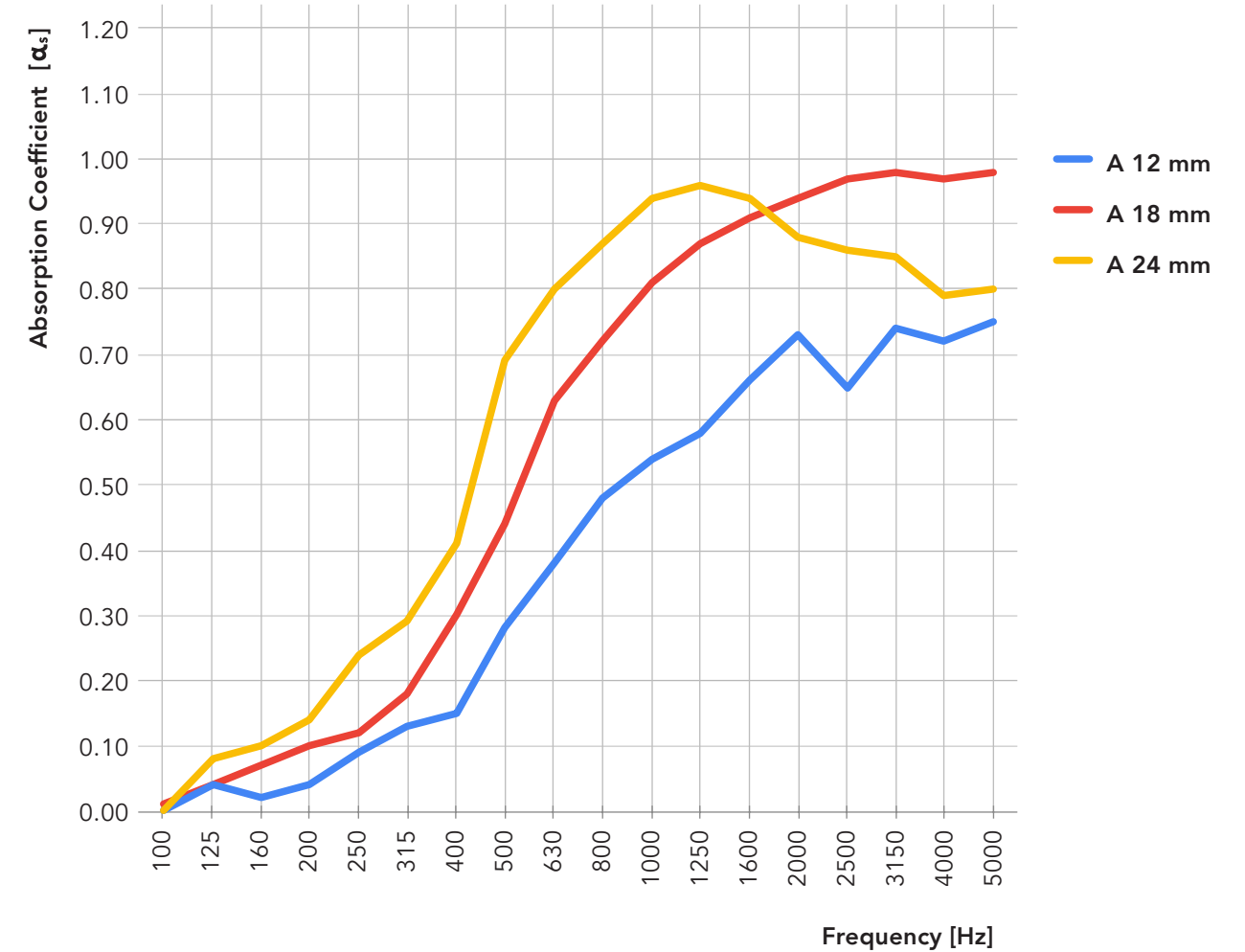

	NRC	SAA	200	250	315	400	500	630	800	1000	1250	1600	2000	2500
A 12 mm	0.40	0.39	0.04	0.09	0.13	0.15	0.28	0.38	0.48	0.54	0.58	0.66	0.73	0.65
A 18 mm	0.60	0.58	0.10	0.12	0.18	0.30	0.44	0.63	0.72	0.81	0.87	0.91	0.94	0.97
A 24 mm	0.70	0.67	0.14	0.24	0.29	0.41	0.69	0.80	0.87	0.94	0.96	0.94	0.88	0.86

Installation

Specify one of the following options at the time of ordering.

Construction Adhesive

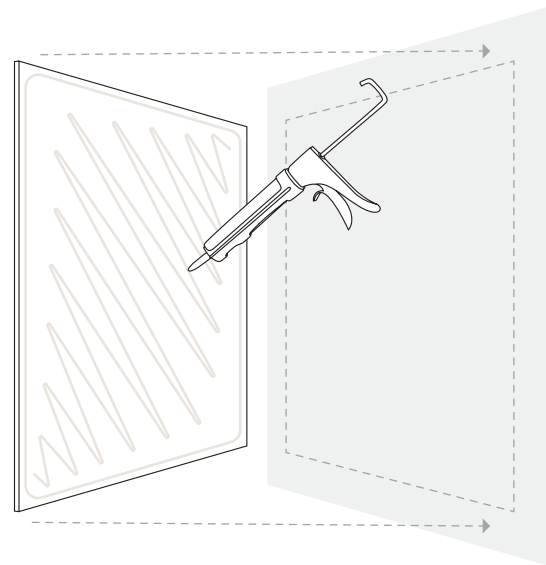
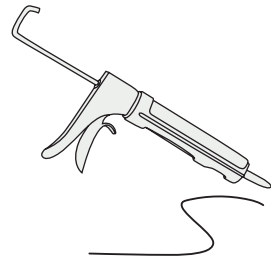

- By others
- Recommendation
- Liquid Nails Heavy Duty (Low VOC) LN-903
- Alternatives
- LePage PL Premium
 - LePage PL Premium Max
 - LePage No More Nails Heavy Duty
 - LePage No More Nails Ultimate Crystal Clear
 - (At your discretion, other construction adhesive may be used but should be tested for effectiveness)

Z-clips (KT-ZCLP-00)

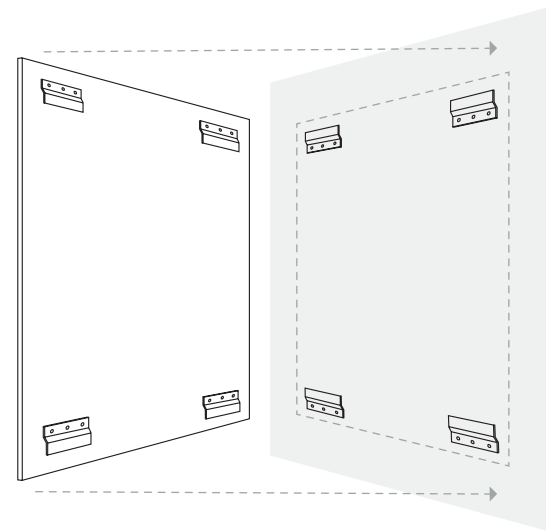
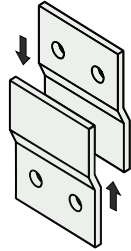

- 6 mm (1/4 in) projection from the wall
- 25 mm (1 in) clearance required above the panel

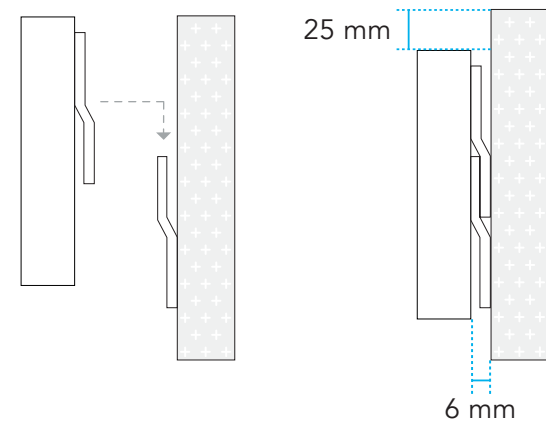

Push Mounts (KT-PUSH-00)

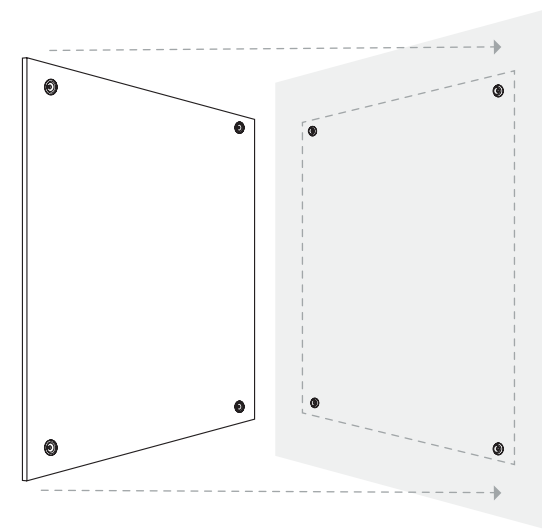
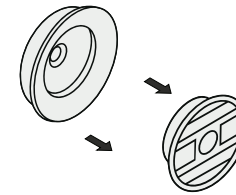

- Panels come with mounts pre-installed but receiving mount must be installed on-site

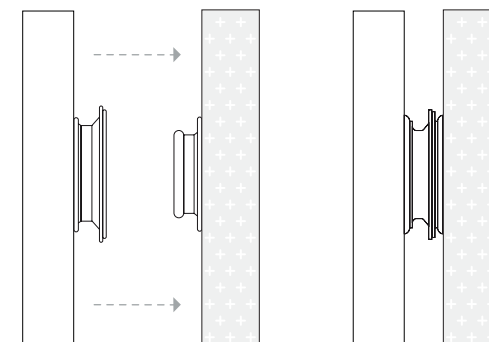

Concealed Mechanical Fasteners (KT-CCAP-00)

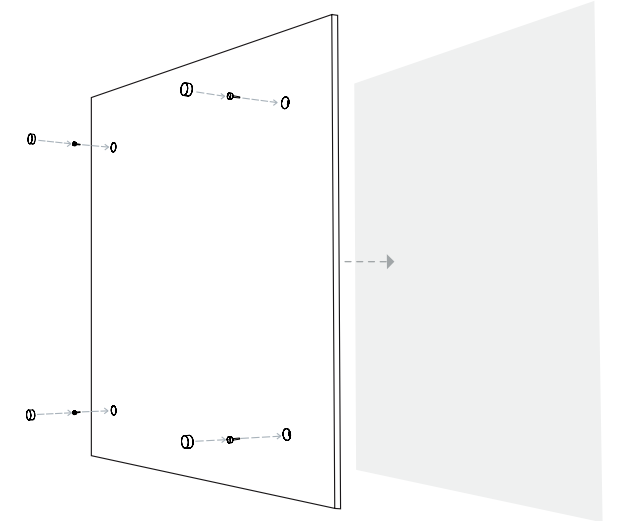
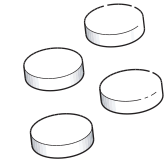

- Concealer Caps
- Provided in matching colour & material as panel
- Mechanical Fasteners
- By others
 - Optional: construction adhesive can be applied for more robust & permanent installation

Product Care

Handling & Storage

Handle products with care so as to avoid folding the polyester felt, chipping its edges or indenting its faces. Store products in their original containers in a well-ventilated area until the intended application environment is ready for installation. Allow products to acclimatize to environmental conditions. Lay them flat on their faces; do not stand them on their edges. Protect from moisture, heat, direct sunlight and the elements.

Maintenance













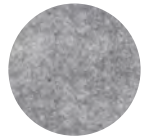
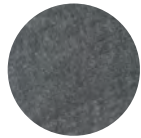





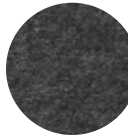







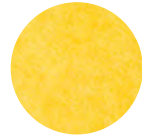

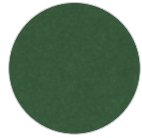
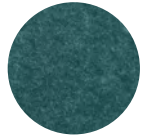
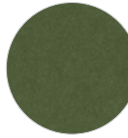
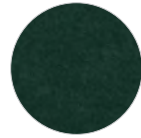
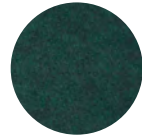
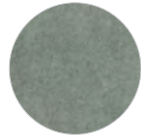
Lightly brush or gently vacuum to remove dust from polyester felt. Clean with warm water and mild, non-toxic soap to remove spills. Test solution on an inconspicuous spot before applying to more visible areas. Blot with a dry cloth after applying the solution to avoid saturating the material. Avoid applying too much pressure when cleaning the products.

Warranty

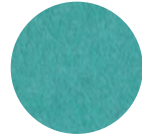
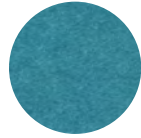
AKUSTUS warrants the construction and finish of all our products to be free from defects in material and workmanship for a period of 1 year from the date of purchase.

Colours

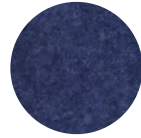
* 12/24 mm only

					
Pure White SP 07	Urban Grey SP 79	Pumice SP 11	Cool Grey SP 36	Mid Grey SP 37	Black SP 13
					
Ivory SP 77	Beige SP 04	Sandstone SP 12	Taupe Grey * SP 90	Warm Grey SP 76	Graphite SP 03
					
Castlerock * SP 80	Blush Pink SP 81	Plum SP 72	Red SP 08	Orange SP 46	Yam SP 28
					
Mustard * SP 87	Sunflower SP 05	Chartreuse SP 43	Moss * SP 89	Peacock * SP 82	Olive * SP 88
					
Ocean Green * SP 86	Forest Green SP 17	Desert Sage SP 78	Deep Sea Blue * SP 83	Krypton SP 30	Pale Teal SP 74
					
Lagoon * SP 84	Aquamarine SP 73	Dark Turquoise SP 71	Azure * SP 85	Sky Blue SP 25	Navy SP 01
					
Midnight Blue SP 19	Purple SP 50				