



# Cocoon Cloud

BY AKUSTUS DESIGNS





CCN-CL-059-060, CCN-CL-139-140 & CCN-CL-099-100

The roundness of the **Cocoon Cloud** reflects the audial and visual comfort that it offers to any space it inhabits. Available in varying sizes, you can suspend multiple versions to create a fascinating collection of clouds that accentuate the aesthetic appeal of a space. Transform the soundscape with this acoustic solution and enhance the atmosphere that much more.





CCN-CL-179-180



# Dimensions

\* Custom shape and size available.

**CCN-CL-040-040**

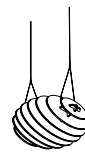
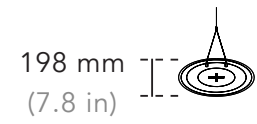
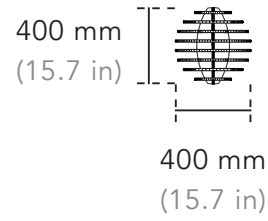

**CCN-CL-179-180**

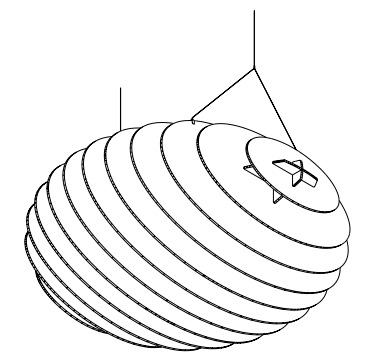
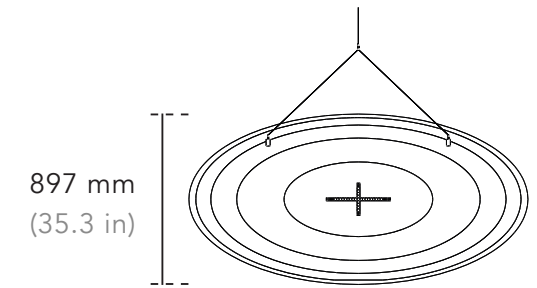
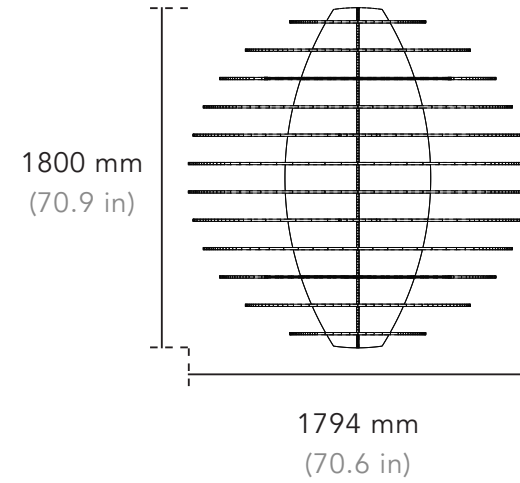

**CCN-CL-059-060**

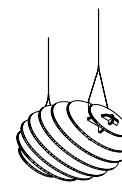
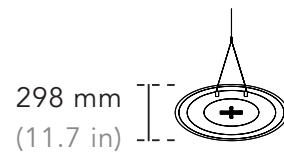
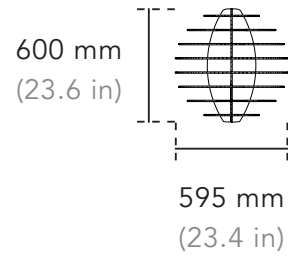

**CCN-CL-099-100**

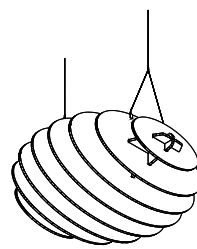
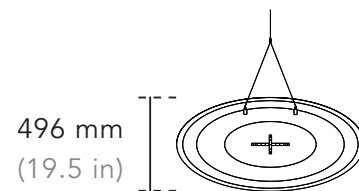
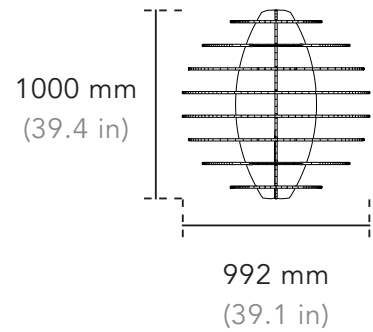

**CCN-CL-139-140**

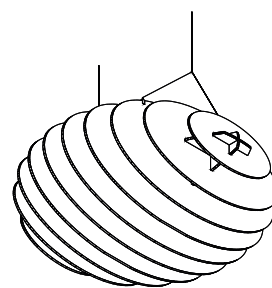
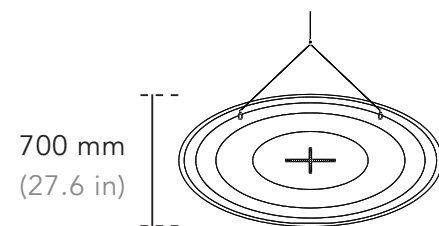
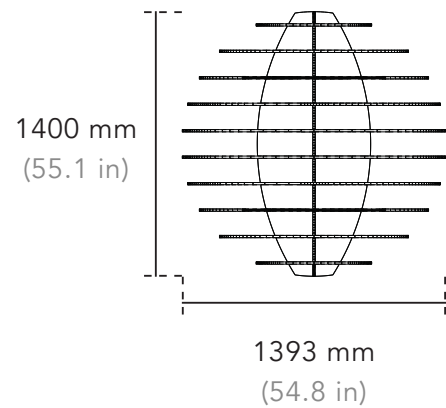

## Product Data

Product Code	Width x Length	Height	Weight
CCN-CL-040-040	400 x 400 mm 15.7 x 15.7 in	198 mm 7.8 in	1 kg 2.2 lb
CCN-CL-059-060	595 x 600 mm 23.4 x 23.6 in	298 mm 11.7 in	2.4 kg 5.3 lb
CCN-CL-099-100	992 x 1000 mm 39.1 x 39.4 in	496 mm 19.5 in	6.5 kg 14.3 lb
CCN-CL-139-140	1393 x 1400 mm 54.8 x 55.1 in	700 mm 27.6 in	15.4 kg 34 lb
CCN-CL-179-180	1794 x 1800 mm 70.6 x 70.9 in	897 mm 35.3 in	29.6 kg 65.3 lb

# Specifications

<b>Product Name</b>	Cocoon Cloud
<b>Composition</b>	100% polyester fibre
<b>Edge Detail</b>	Square edge
<b>Fire Rating</b>	<ul style="list-style-type: none"> <li>• ASTM E84 Class A</li> <li>• CAN/ULC-S102.2-10</li> </ul>
<b>VOC Emissions</b>	CDPH (CA 01350)
<b>Antimicrobial Testing</b>	Mould & mildew resistant
<b>Sustainability</b>	<ul style="list-style-type: none"> <li>• 100% recyclable</li> <li>• LBC Red List free</li> <li>• Contributes to LEED certification</li> <li>• Free of toxic substances and of off-gassing</li> <li>• Made with ~60% recycled content from plastic water bottles</li> </ul>

<b>How to Specify</b>	<ul style="list-style-type: none"> <li>• Product Name &amp; Code</li> <li>• Dimensions</li> <li>• Colour</li> <li>• Installation Method</li> </ul>
-----------------------	--

**Colour & Texture Variations** The felting and dyeing process that forms the material contributes to its unique texture but also to variations in texture and colour from panel to panel. Products will be provided within an acceptable range of variation.



# Acoustic Properties

The following values reflect the acoustic properties of the product as tested in accordance with ASTM C423-09a using Type J mounting.

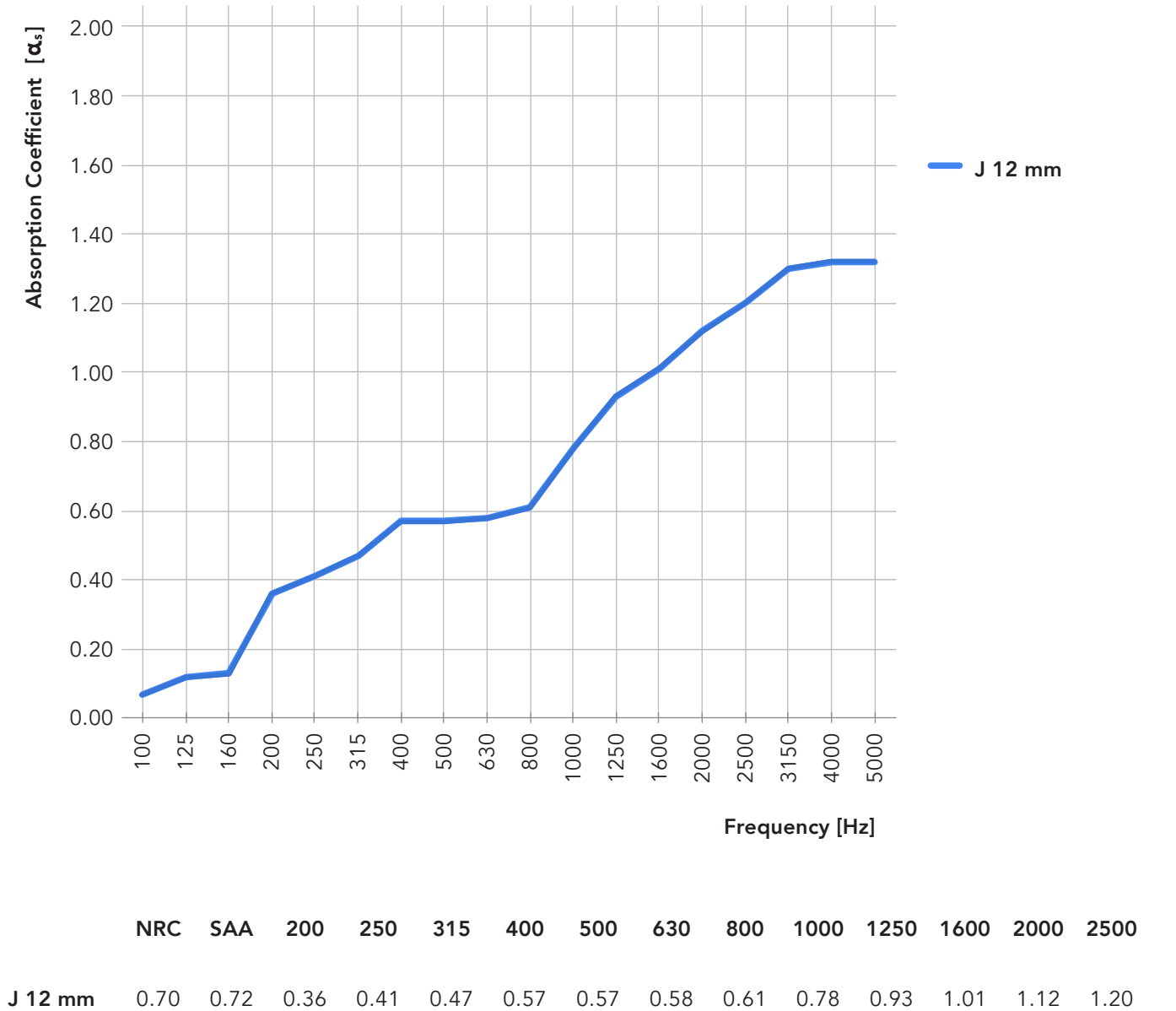

# Installation - Cocoon Cloud Kit (KT-CNCL-00)

Specify optional ceiling hardware at the time of ordering.

## Ceiling Hardware Options

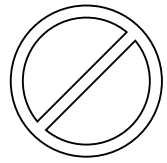

No Hardware  
(default)

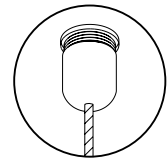

Cable Coupler  
(KT-CCPL-00)

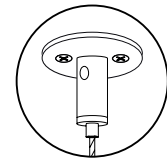

Adjustable Cable Gripper  
(KT-CGRP-00)

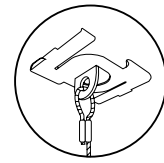

T-bar Clips  
(KT-TCLP-00)

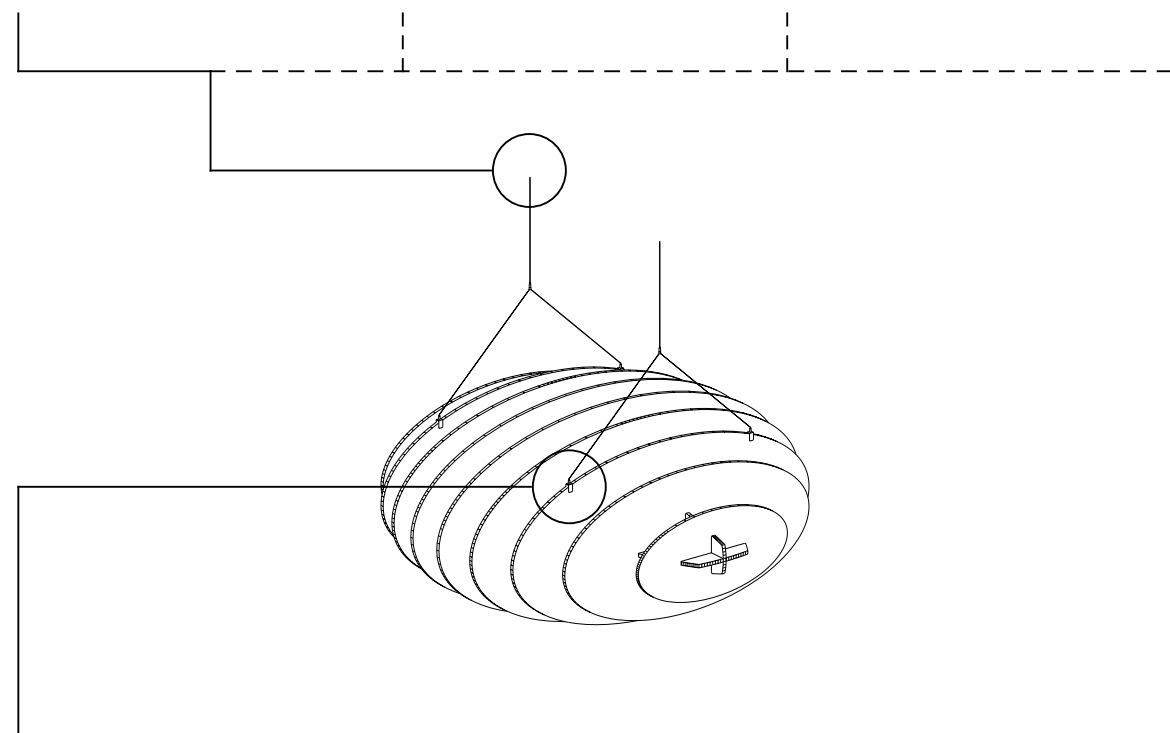

## Product Hardware

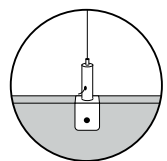

Panel Clamp with  
Adjustable Cable Gripper

- Standard silver metal finish

# Product Care

## Handling & Storage

Handle products with care so as to avoid folding the polyester felt, chipping its edges or indenting its faces. Store products in their original containers in a well-ventilated area until the intended application environment is ready for installation. Allow products to acclimatize to environmental conditions. Lay them flat on their faces; do not stand them on their edges. Protect from moisture, heat, direct sunlight and the elements.

## Maintenance

Lightly brush or gently vacuum to remove dust from polyester felt. Clean with warm water and mild, non-toxic soap to remove spills. Test solution on an inconspicuous spot before applying to more visible areas. Blot with a dry cloth after applying the solution to avoid saturating the material. Avoid applying too much pressure when cleaning the products.

## Warranty

AKUSTUS warrants the construction and finish of all our products to be free from defects in material and workmanship for a period of 1 year from the date of purchase.





# Colours

\* 12/24 mm only



Pure White  
SP 07



Urban Grey  
SP 79

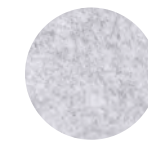

Pumice  
SP 11

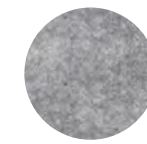

Cool Grey  
SP 36

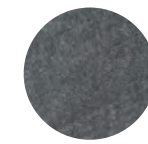

Mid Grey  
SP 37



Black  
SP 13



Ivory  
SP 77



Beige  
SP 04



Sandstone  
SP 12



Taupe Grey \*  
SP 90



Warm Grey  
SP 76

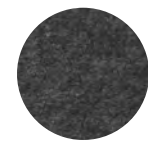

Graphite  
SP 03

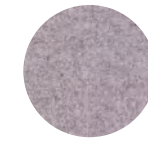

Castlerock \*  
SP 80



Blush Pink  
SP 81



Plum  
SP 72

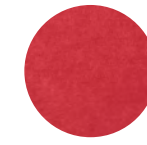

Red  
SP 08

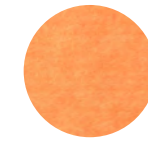

Orange  
SP 46

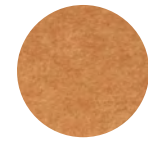

Yam  
SP 28



Mustard \*  
SP 87

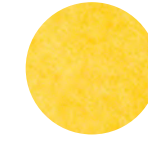

Sunflower  
SP 05



Chartreuse  
SP 43

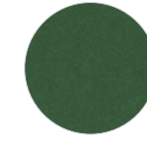

Moss \*  
SP 89

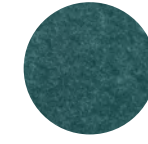

Peacock \*  
SP 82

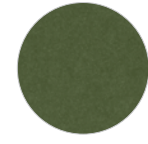

Olive \*  
SP 88



Ocean Green \*  
SP 86



Forest Green  
SP 17

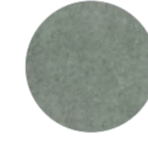

Desert Sage  
SP 78



Deep Sea Blue \*  
SP 83



Krypton  
SP 30



Pale Teal  
SP 74



Lagoon \*  
SP 84



Aquamarine  
SP 73



Dark Turquoise  
SP 71



Azure \*  
SP 85



Sky Blue  
SP 25



Navy  
SP 01

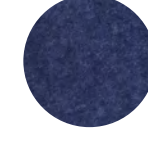

Midnight Blue  
SP 19



Purple  
SP 50