

Metro Wall Panel

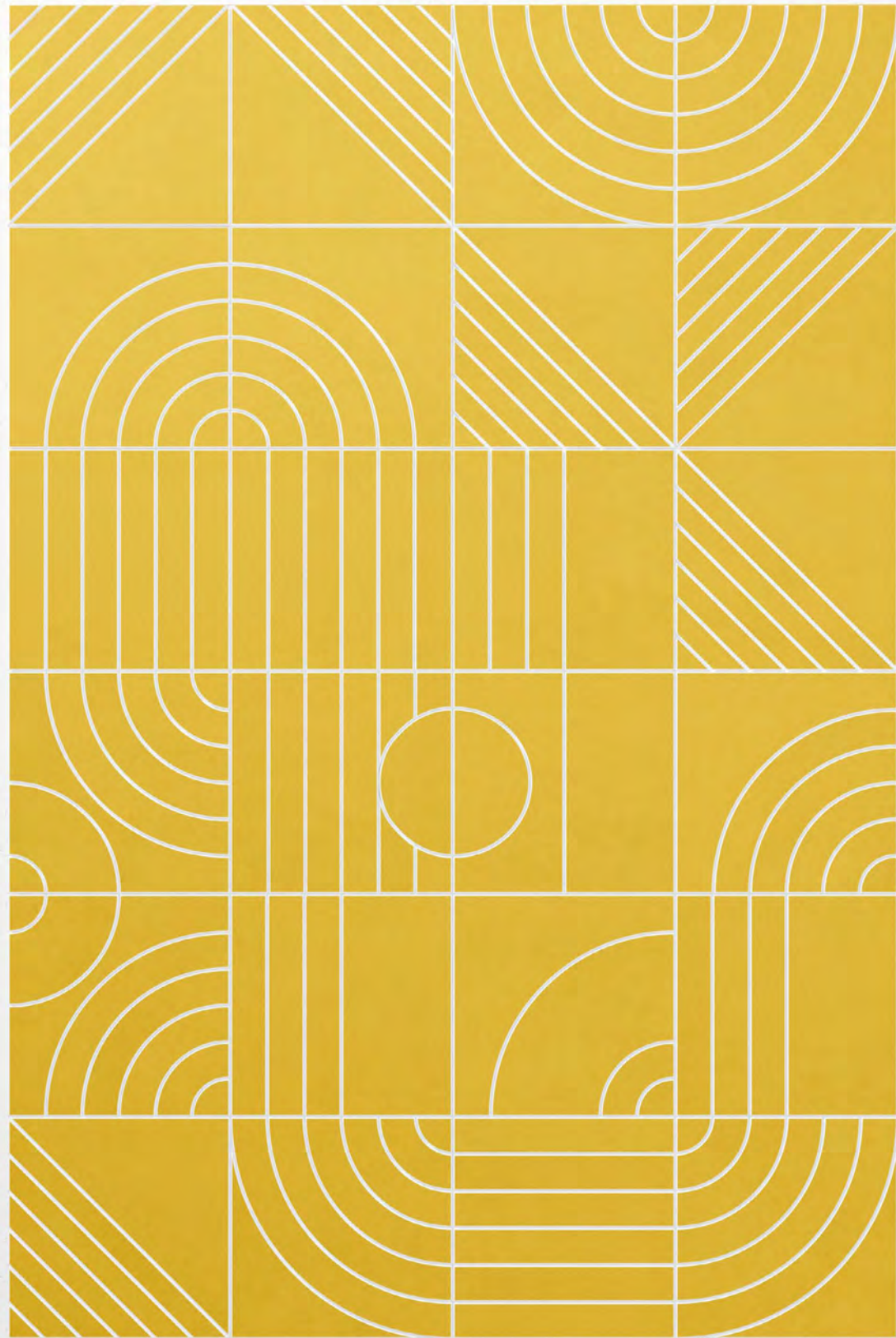



Methodical curves and parallel lines come together in the Metro Wall Panel. Like a complex train system, Metro's intricate network whisks you away to see the sights while cutting out the noise.

How to Specify

Step by step instructions on how to specify Metro Wall Panels.

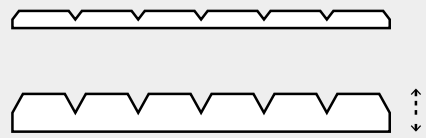

01

Choose a thickness.

(pg 03)

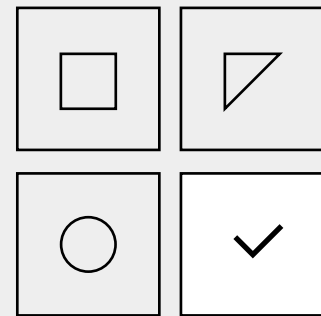

02

Option A

Choose a panel design and create your own configuration.

Option B

Choose one of our configurations.

(pg 04-05)

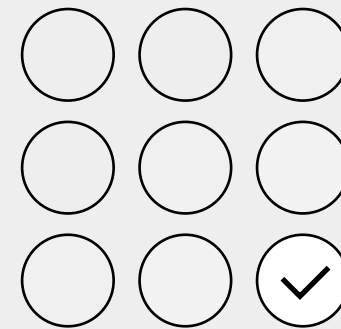

03

Choose a standard colour or Impressio Colourways.

(pg 06-10)

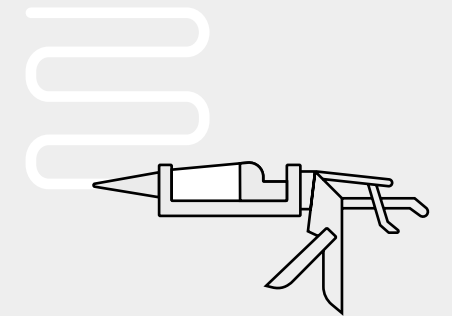

04

Choose an installation method. (pg 11)

Dimensions

Standard Dimensions (mm)

600 W x 600 H

Standard Thicknesses (mm)

12, 18, and 24

Edge Detail

Bevel edge

Customization

Panel Width and Height can be adjusted to fit your space.

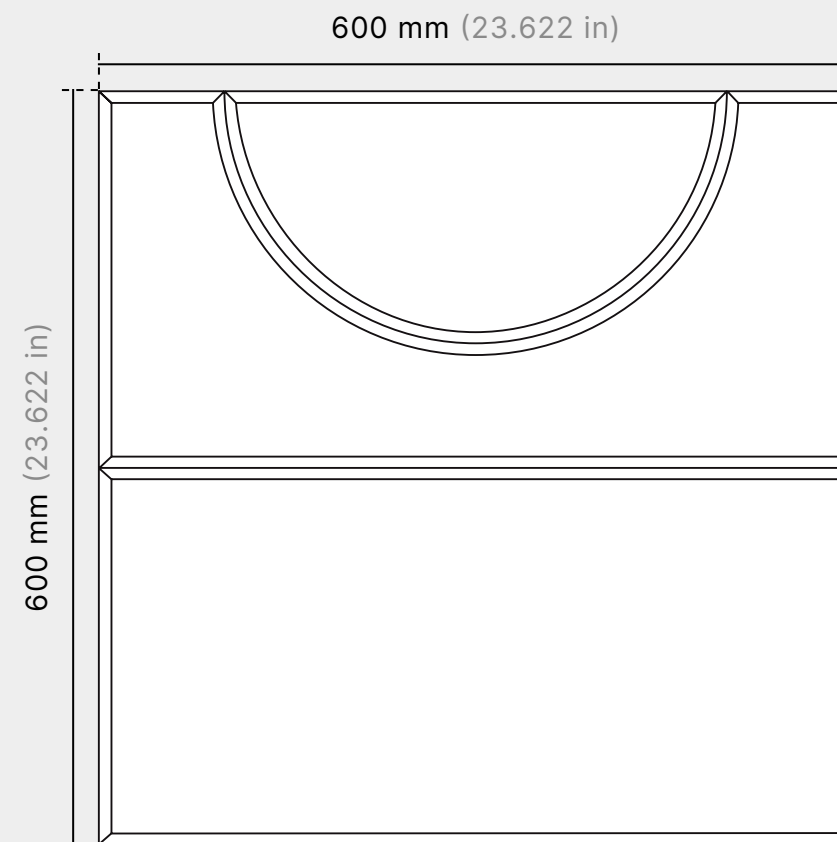

Bevel Edge

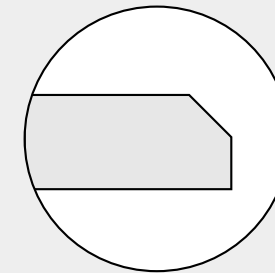

Panel Designs

The building blocks of the Metro Wall Panel.

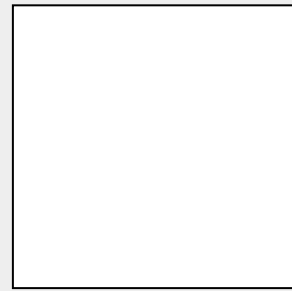

Panel 01

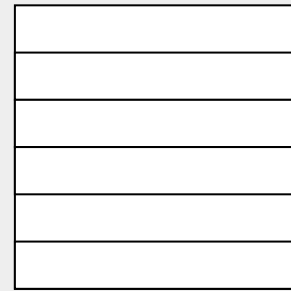

Panel 02

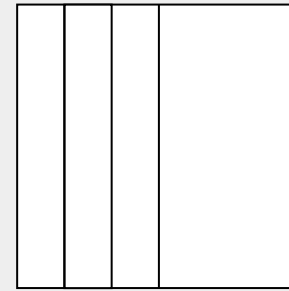

Panel 03

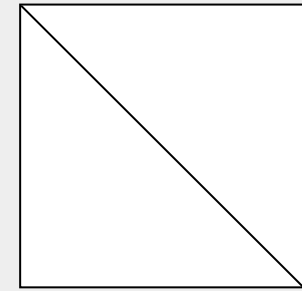

Panel 04

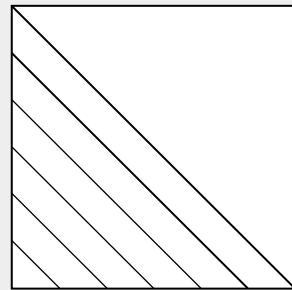

Panel 05

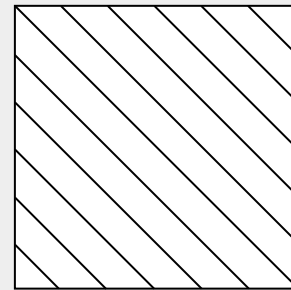

Panel 06

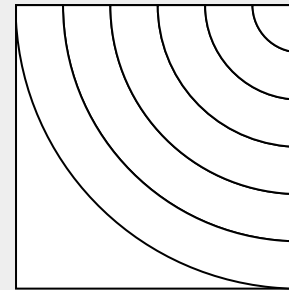

Panel 07

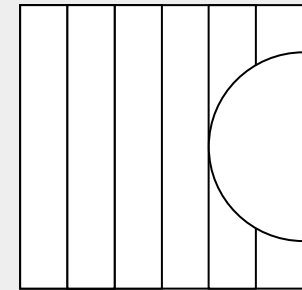

Panel 08

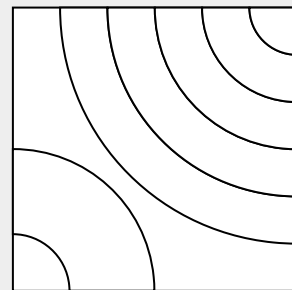

Panel 09

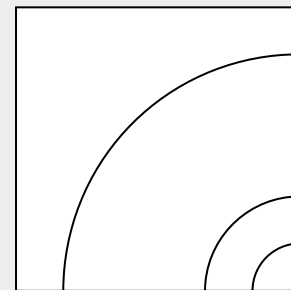

Panel 10

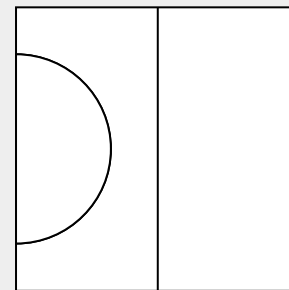

Panel 11

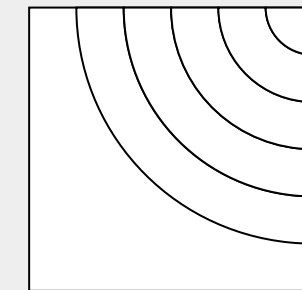

Panel 12

Configurations

Mix and match panel designs to make the wall your own, or choose from what we've come up with here.

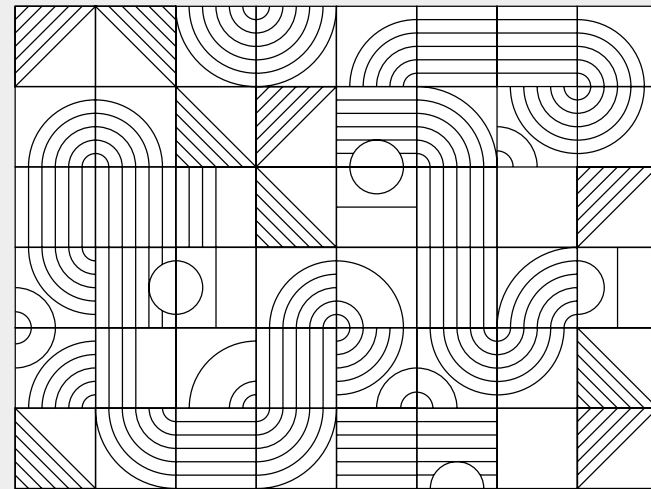

Config A

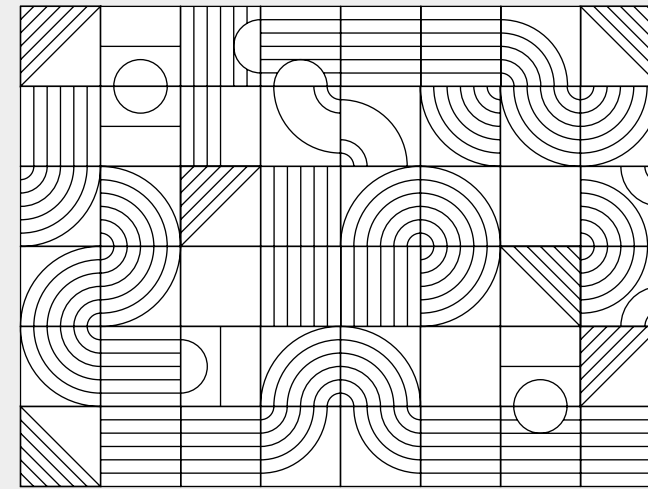

Config B

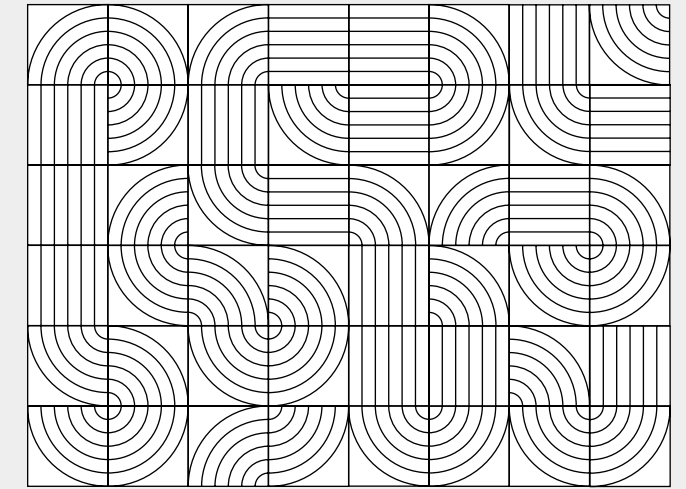

Config C

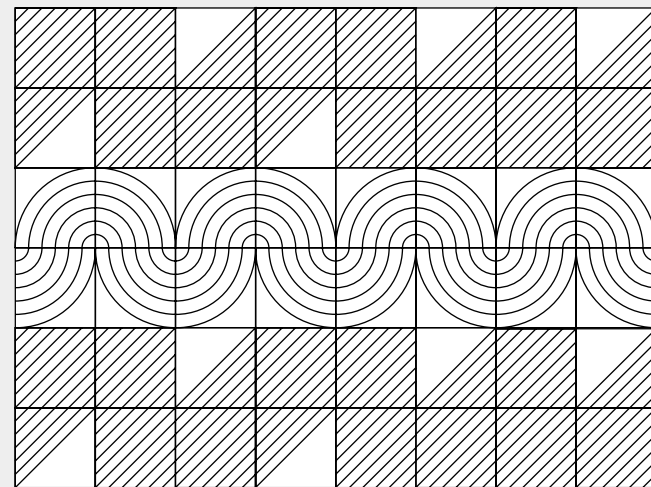

Config D

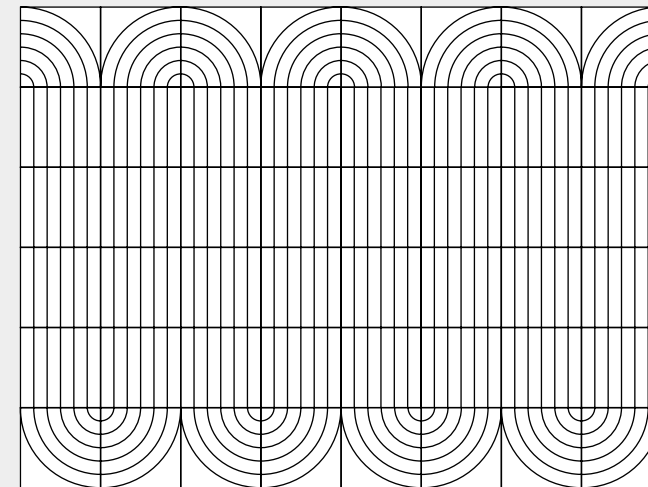

Config E

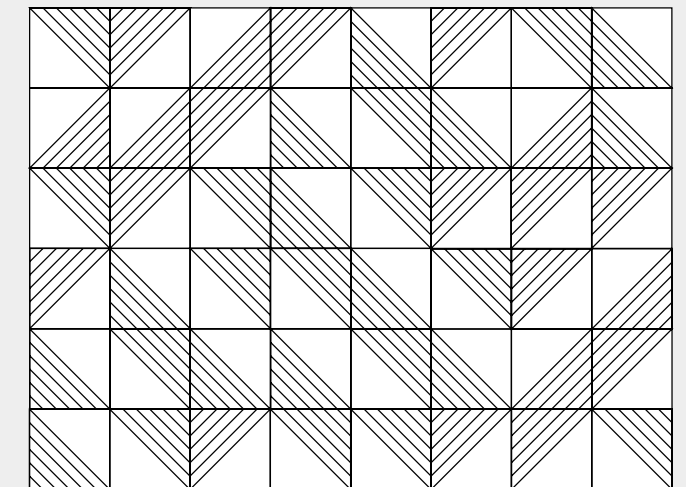

Config F

Customization

Metro is designed for customization. Ask us about changing the panel design, configuration or colour to fit your space.

Impressio Colourways

Impressio Colourways are unique colours curated for Metro. Each set complements the design and allows the twists and turns of the panels to shine through.

Vancouver



VA 01

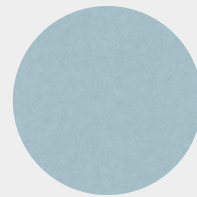

VA 02

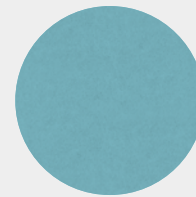

VA 03

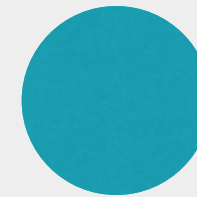

VA 04

New York



NY 01

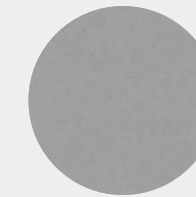

NY 02

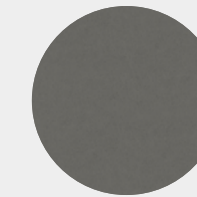

NY 03

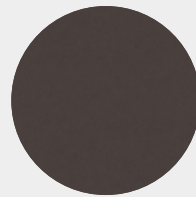

NY 04

Madrid



MA 01

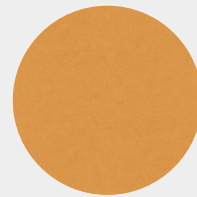

MA 02

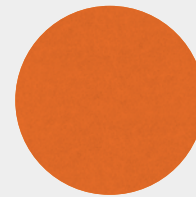

MA 03

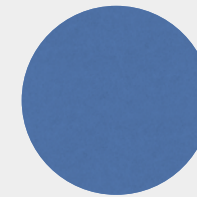

MA 04

Sao Paulo



SA 01



SA 02

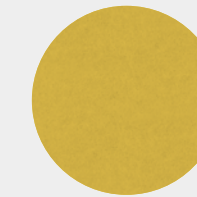

SA 03

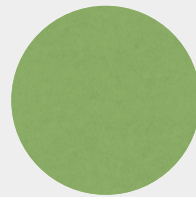

SA 04

Colourways can be specified in either one colour, two colours or multi colour.

Seoul

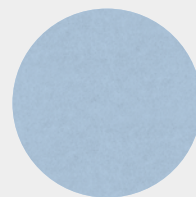

SE 01

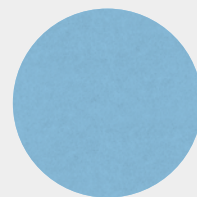

SE 02

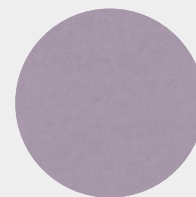

SE 03

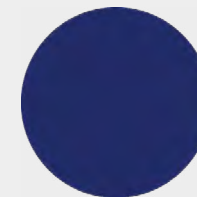

SE 04

Dubai



DU 01



DU 02

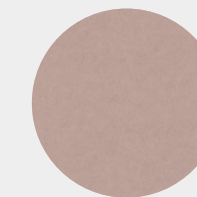

DU 03

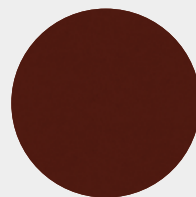

DU 04

Impressio Colourways One Colour

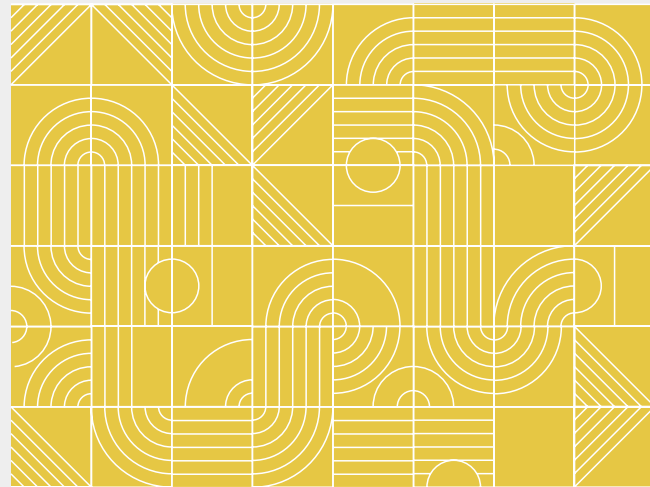

Config A in Sao Paulo Colorways.

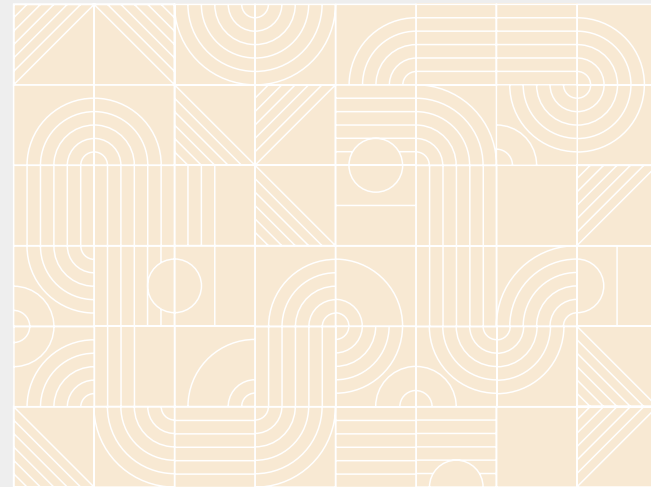

Config A in Madrid Colorways.

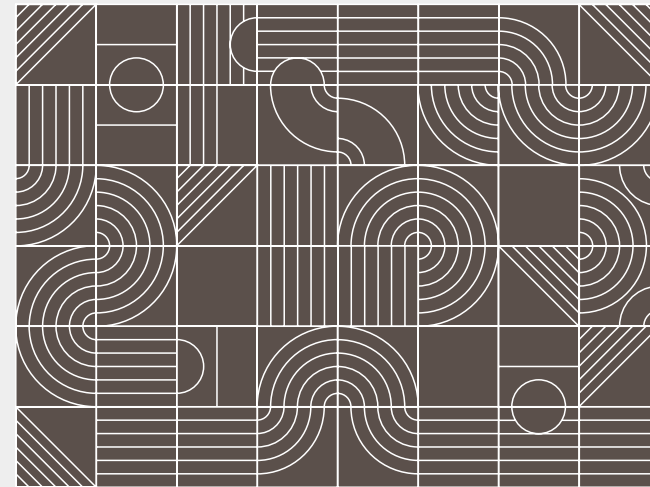

Config B in New York Colorways.

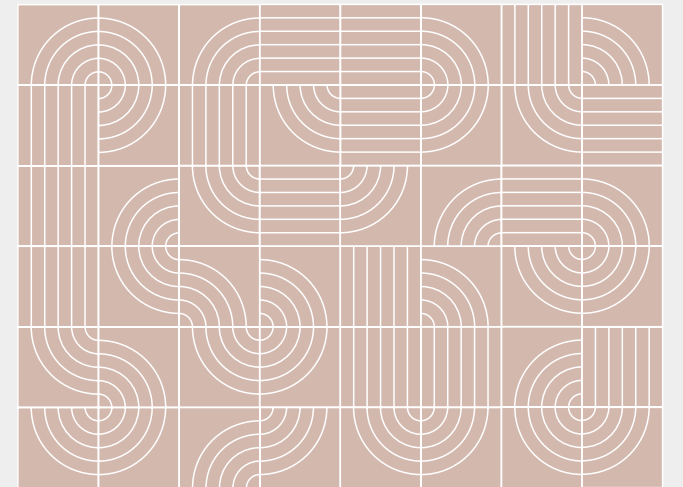

Config C in Dubai Colorways.

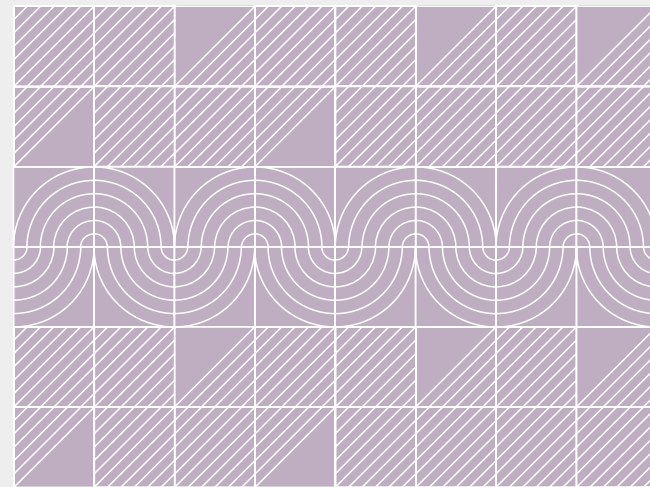

Config D in Seoul Colorways.

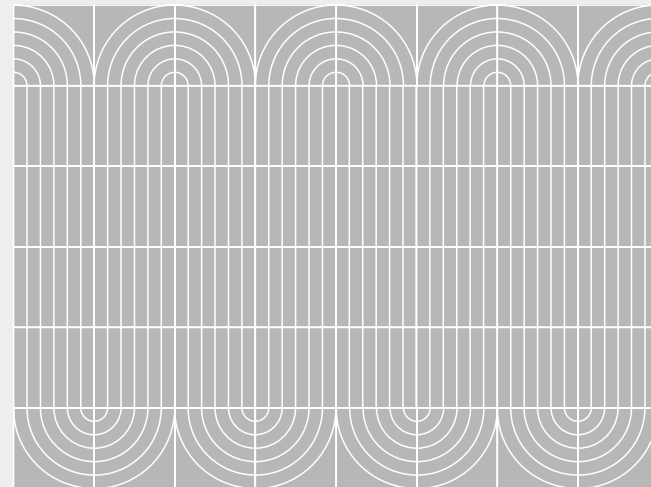

Config E in New York Colorways.

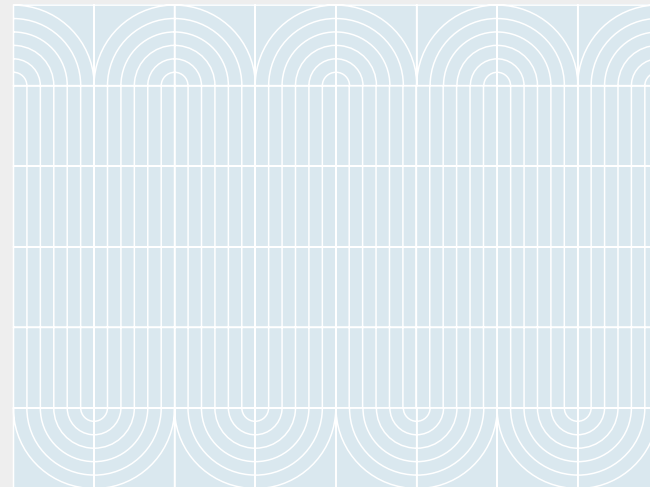

Config E in Vancouver Colorways.

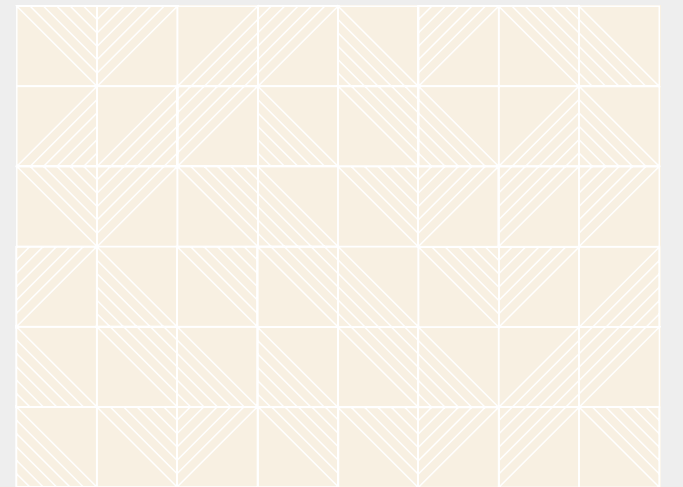

Config F in Sao Paulo Colorways.

Impressio Colourways Two Colours

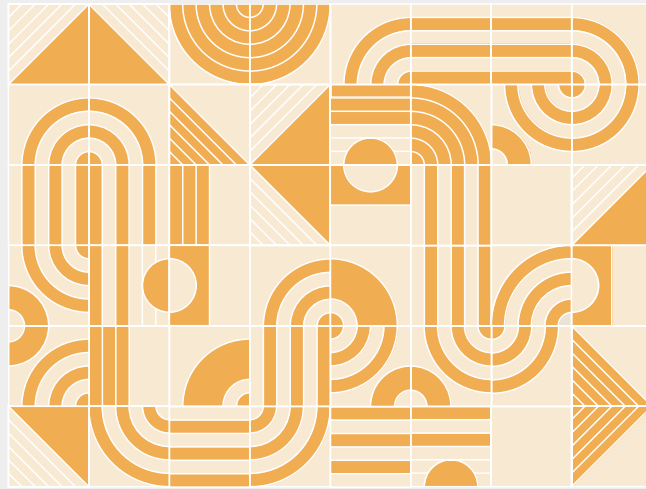

Config A in Madrid Colorways.

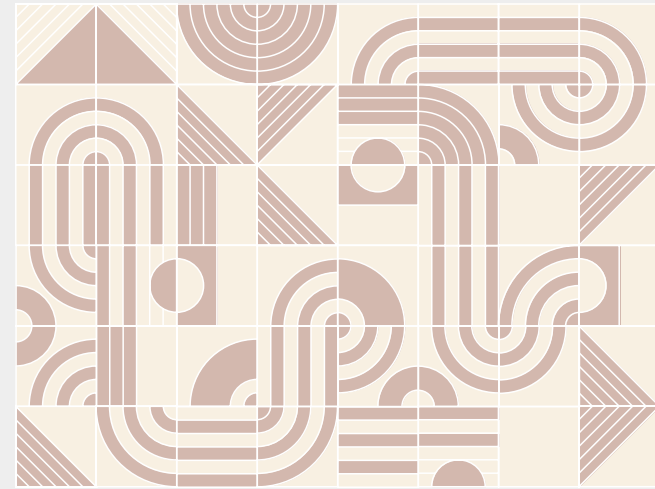

Config A in Dubai Colorways.

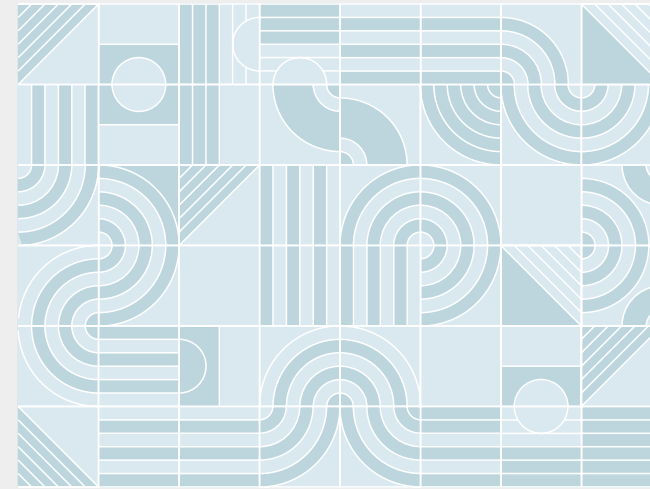

Config B in Vancouver Colorways.

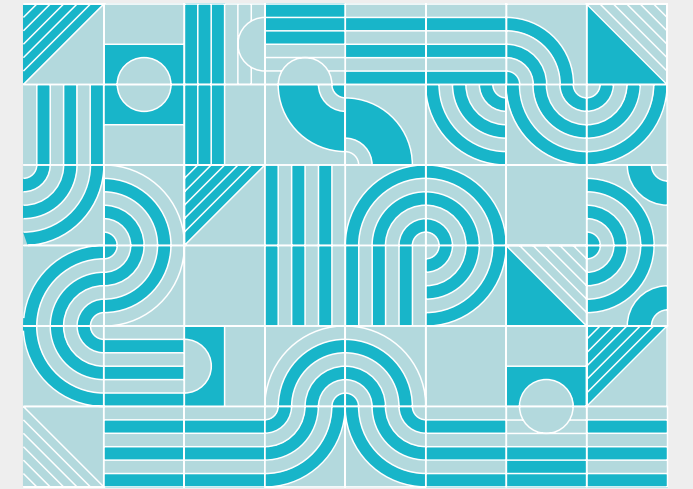

Config B in Vancouver Colorways.

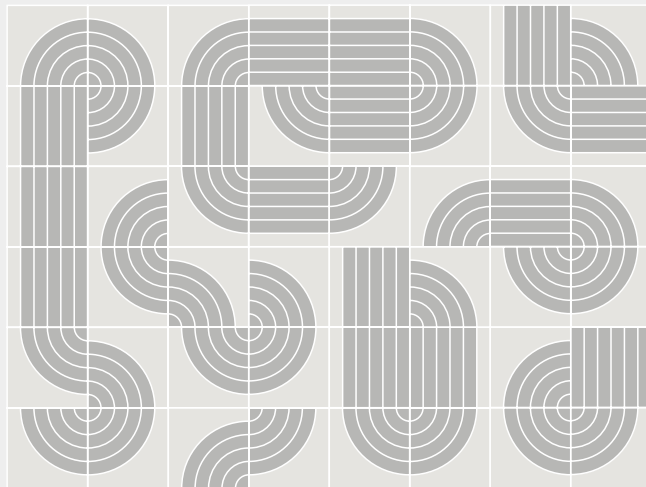

Config C in New York Colorways.

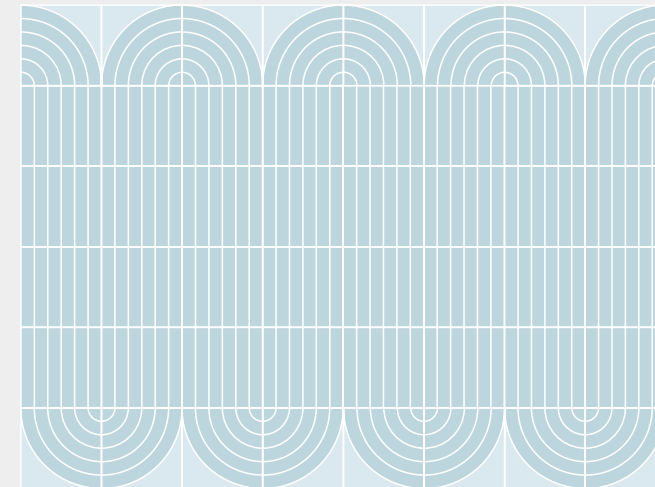

Config E in Vancouver Colorways.

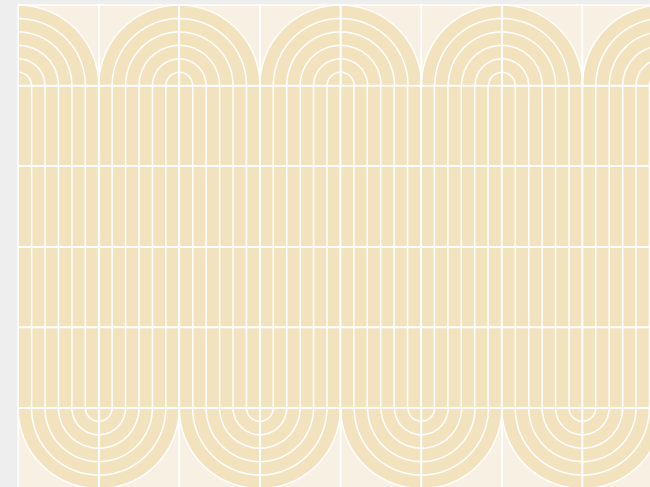

Config E in Sao Paulo Colorways.

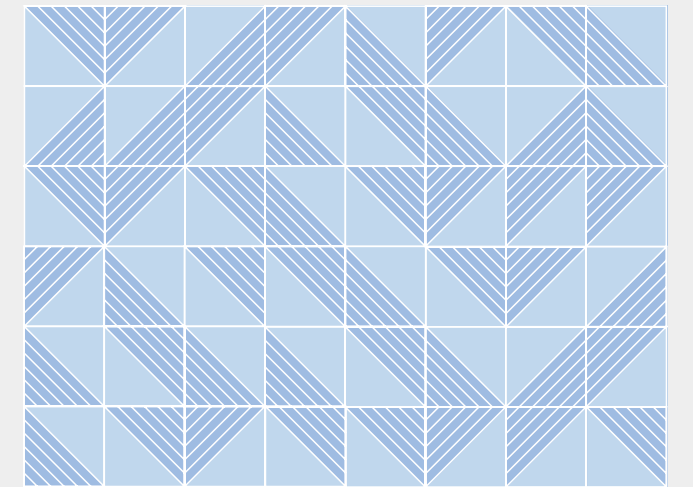

Config F in Seoul Colorways.

Impressio Colourways Multi Colour

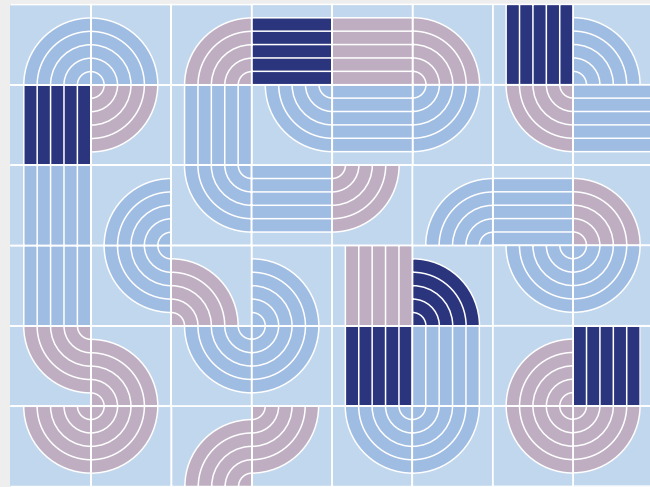

Config C in Seoul Colorways.

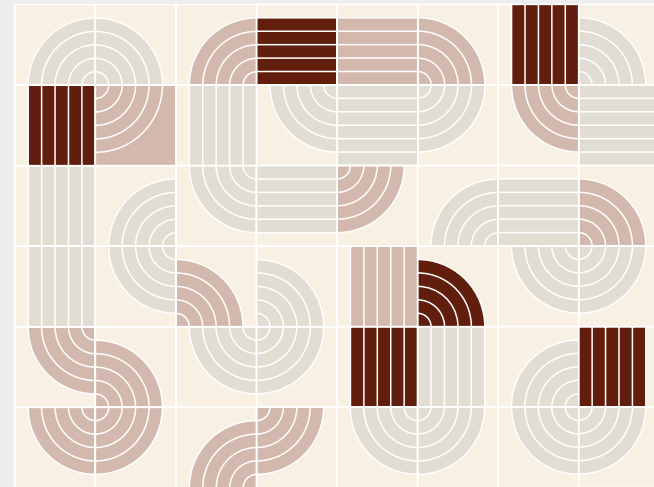

Config C in Dubai Colorways.

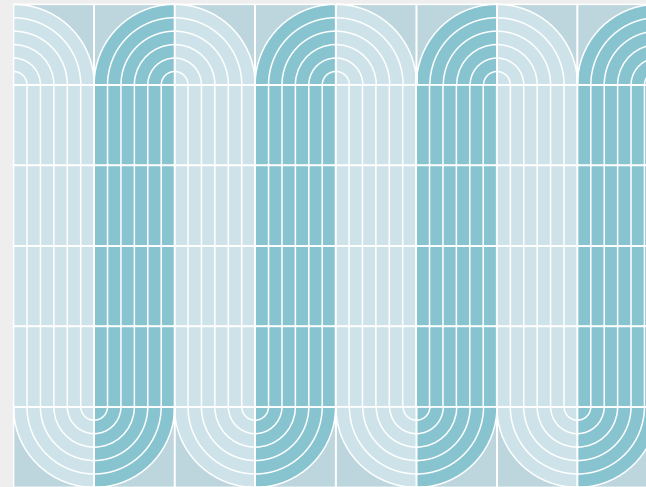

Config E in Vancouver Colorways.

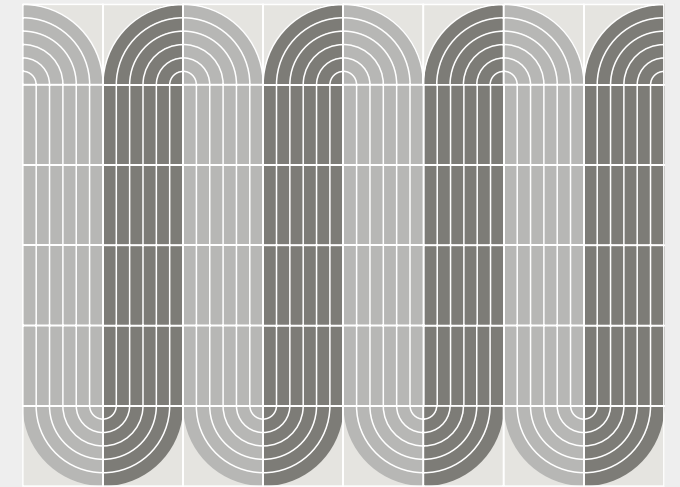

Config E in New York Colorways.

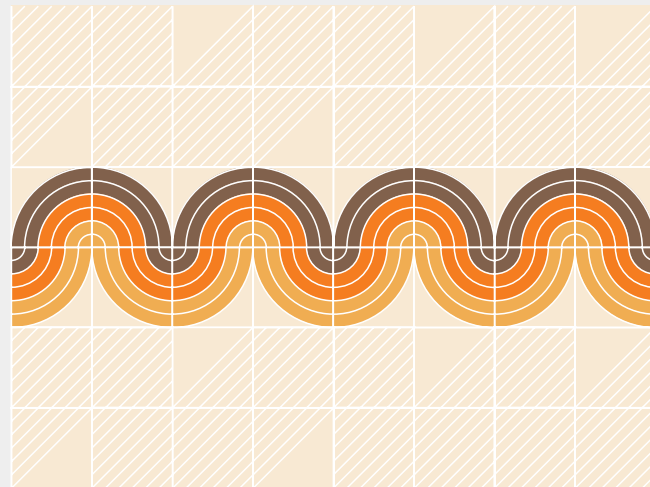

Config D in Madrid Colorways.

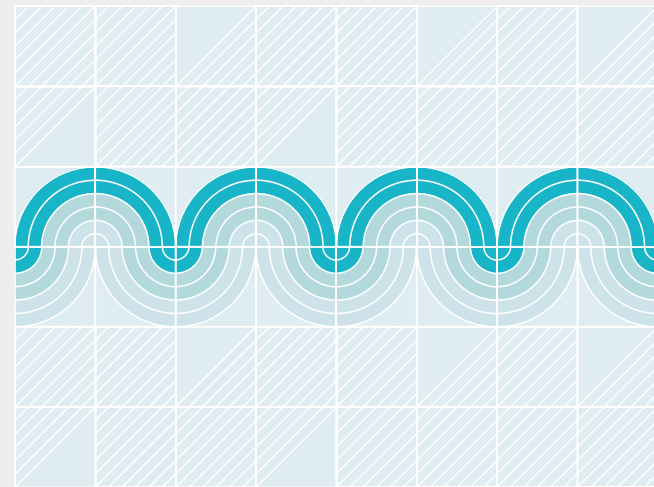

Config D in Vancouver Colorways.

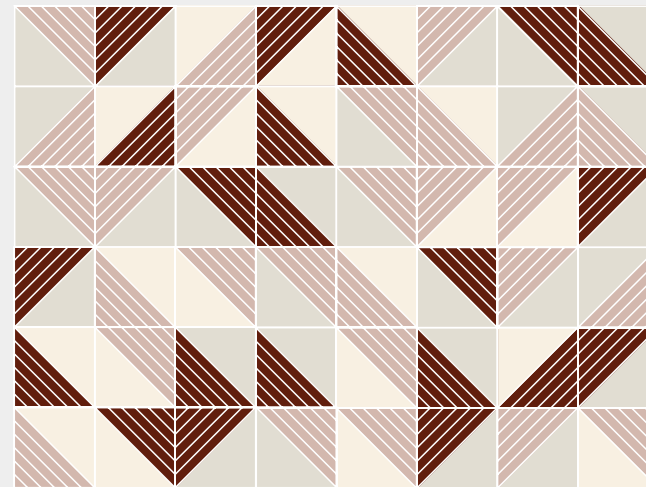

Config F in Dubai Colorways.

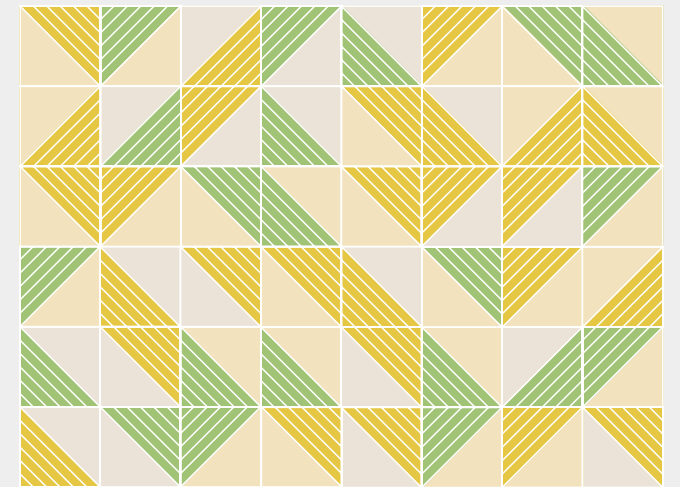

Config F in Sao Paulo Colorways.

Standard Colours

Choose from any one of our standard colours.



Pure White
SP 07



Urban Grey
SP 79

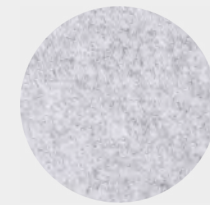

Pumice
SP 11



Warm Grey
SP 76



Cool Grey
SP 36

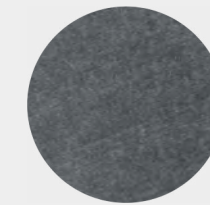

Mid Grey
SP 37

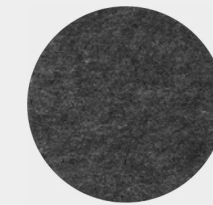

Graphite
SP 03



Black
SP 13



Ivory
SP 77



Beige
SP 04



Sandstone
SP 12

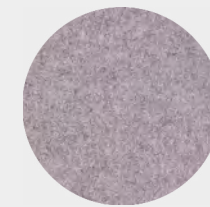

Castlerock**
SP 80



Blush Pink*
SP 81



Wild Currant
SP 48



Plum
SP 72



Red
SP 08

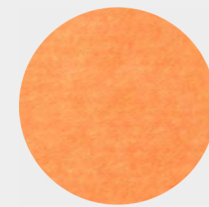

Orange
SP 46

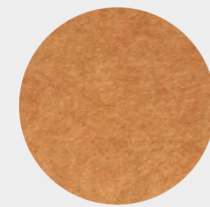

Yam
SP 28

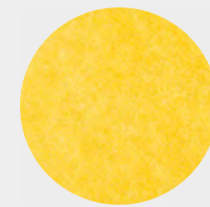

Sunflower
SP 05



Chartreuse
SP 43



Desert Sage
SP 78

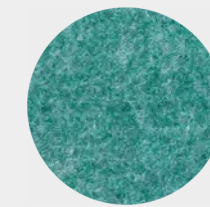

Green*
SP 10

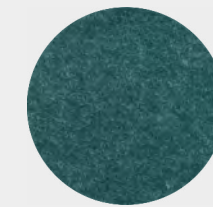

Peacock**
SP 82



Forest Green
SP 17



Krypton
SP 30



Pale Teal
SP 74

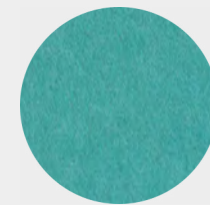

Aquamarine
SP 73

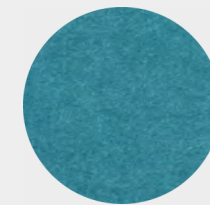

Dark Turquoise
SP 71

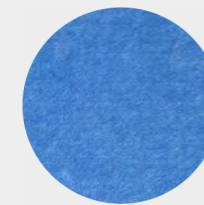

Sky Blue
SP 25



Navy
SP 01



Midnight Blue
SP 19



Purple
SP 50

Don't see something you love? Ask us about creating your own custom colour.

All colours available in 9,12,18, and 24 mm unless noted otherwise.

* Only available in 9mm and 18mm

** Only available in 12mm and 24mm

Installation and Hardware

This is an overview of the available installation methods. Check out our installation guide for more details.

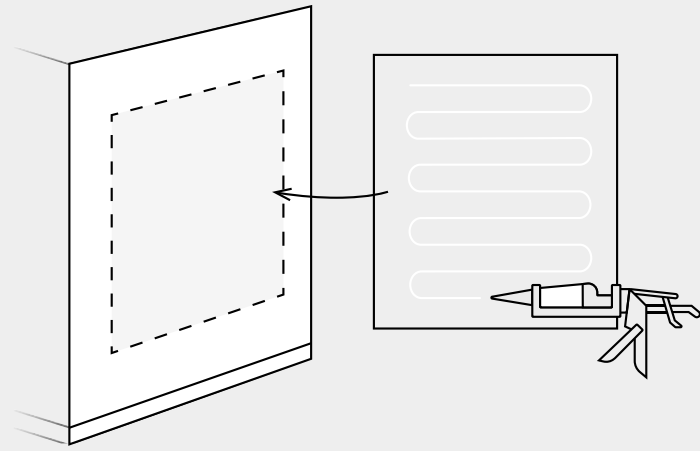

Costruction Adhesive

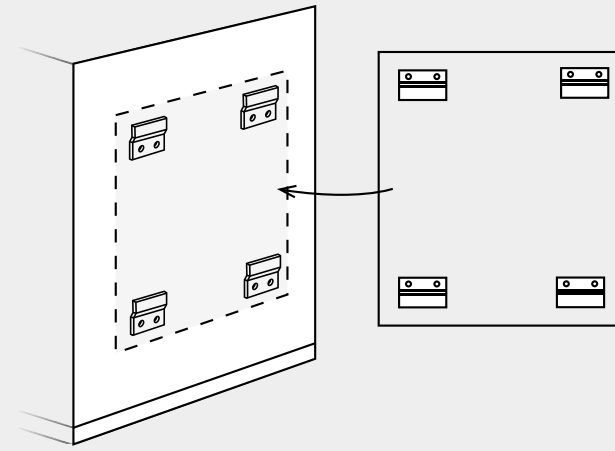

Z-Clips

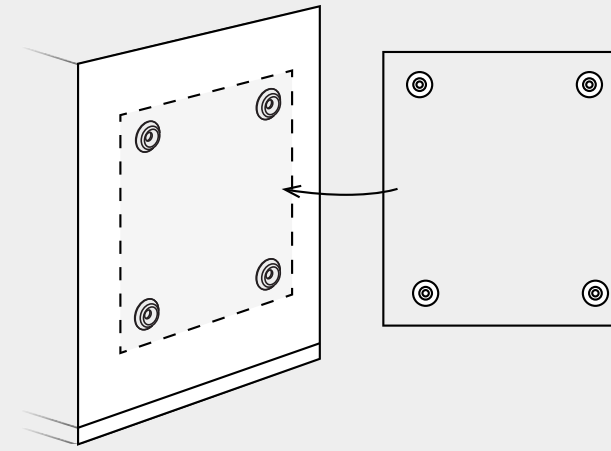

Push Mount Clips

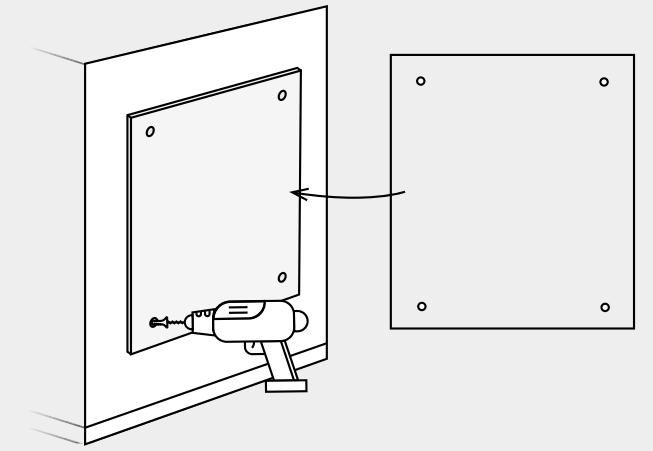

Concealed Mechanical Fasteners

Product Specifications

Metro Wall Panels

Composition

100% polyester fibre

VOC Emissions

CDPH (CA 01350)

Antimicrobial Testing

Mould & mildew resistant

Fire Rating

- ASTM E84 Class A
- CAN/ULC-S102.2-10



Sustainability

- 100% recyclable
- LBC Red List free
- Contributes to LEED certification
- Free of toxic substances and of off-gassing
- Made with ~60% recycled content from plastic water bottles

Colour & Texture Variations

The felting and dyeing process that forms the material contributes to its unique texture but also to variations in texture and colour from panel to panel. Products will be provided within an acceptable range of variation.



Sound Absorption Graph

The following values reflect the acoustic properties of the product as tested in accordance with ASTM C423-09a using Type A mounting.

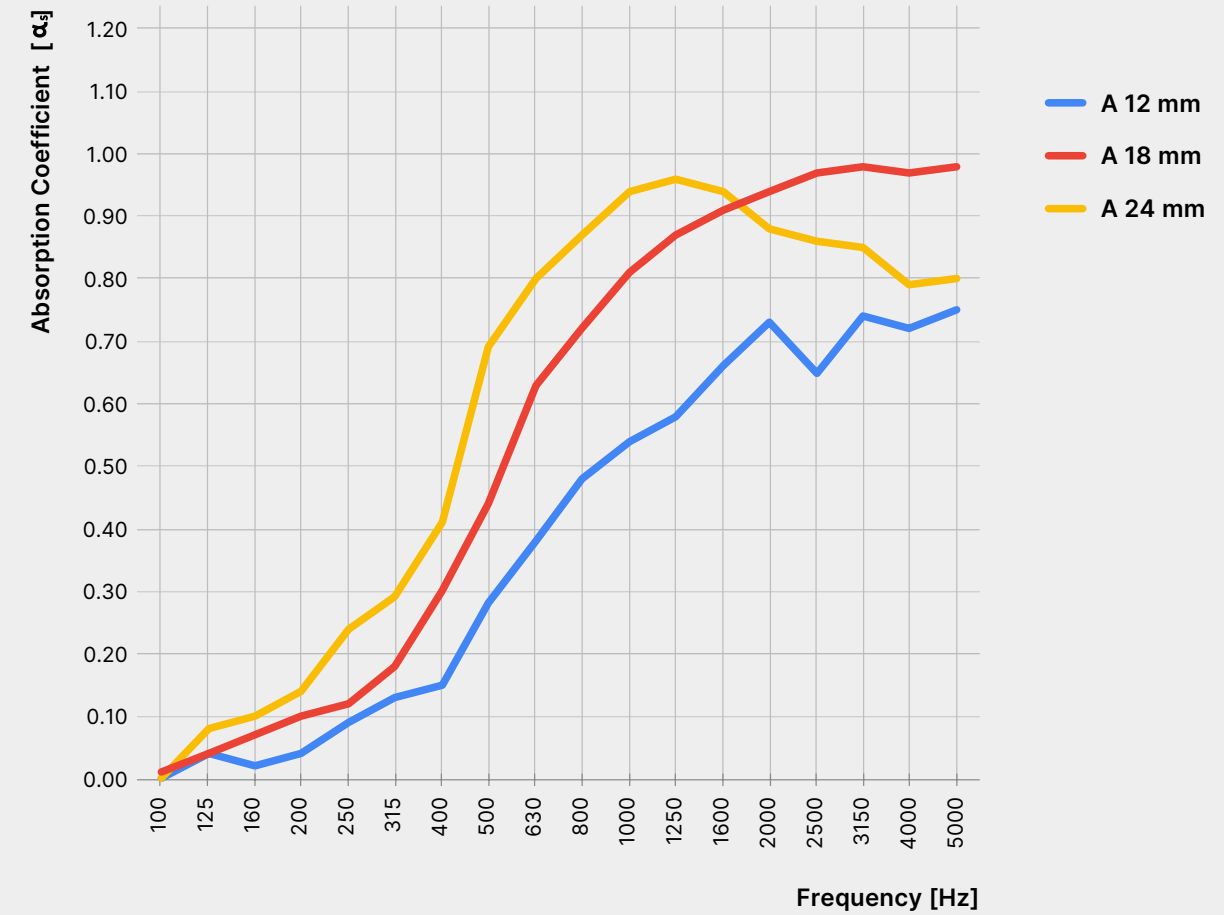

	NRC	SAA	200	250	315	400	500	630	800	1000	1250	1600	2000	2500
A 12 mm	0.40	0.39	0.04	0.09	0.13	0.15	0.28	0.38	0.48	0.54	0.58	0.66	0.73	0.65
A 18 mm	0.60	0.58	0.10	0.12	0.18	0.30	0.44	0.63	0.72	0.81	0.87	0.91	0.94	0.97
A 24 mm	0.70	0.67	0.14	0.24	0.29	0.41	0.69	0.80	0.87	0.94	0.96	0.94	0.88	0.86

Product Care

Handling & Storage

Handle products with care so as to avoid folding the polyester felt, chipping its edges or indenting its faces. Store products in their original containers in a well-ventilated area until the intended application environment is ready for installation. Allow products to acclimatize to environmental conditions. Lay them flat on their faces; do not stand them on their edges. Protect from moisture, heat, direct sunlight and the elements.

Warranty

AKUSTUS warrants the construction and finish of all our products to be free from defects in material and workmanship for a period of 1 year from the date of purchase.

Maintenance

Lightly brush or gently vacuum to remove dust from polyester felt. Clean with warm water and mild, non-toxic soap to remove spills. Test solution on an inconspicuous spot before applying to more visible areas. Blot with a dry cloth after applying the solution to avoid saturating the material. Avoid applying too much pressure when cleaning the products.

