

Diamond Screen

BY AKUSTUS DESIGNS

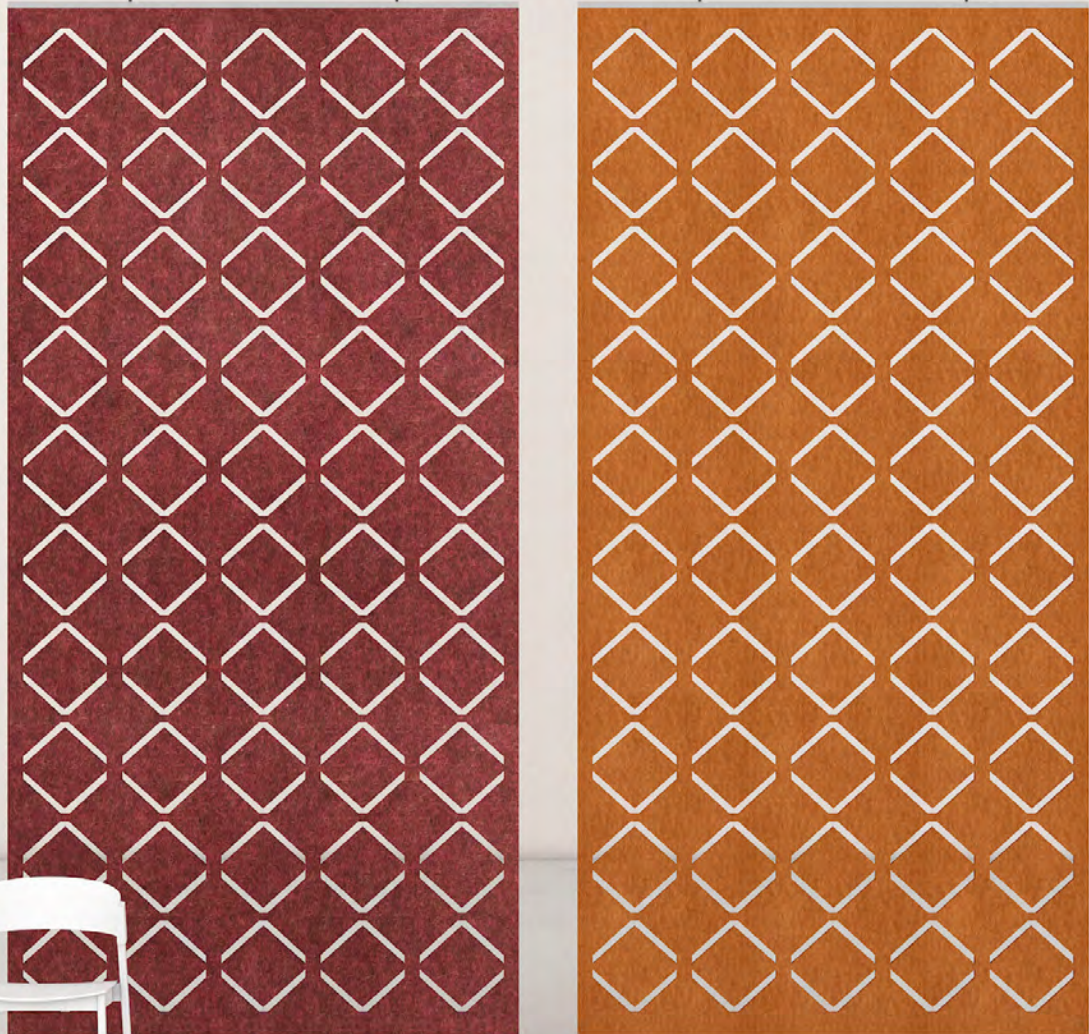

AKUSTUS.COM

INFO@AKUSTUS.COM



DMD-SC-120-240

The **Diamond Screen**'s resemblance to a curtain of crystals lends a graceful elegance and serenity to a room. Suspend these screens as permeable dividers in an open office or in a hotel lobby and add a touch of refinement to the room.



DMD-SC-120-240



Dimensions

Available Thicknesses: 12, 18, 24 mm (0.5, 0.7, 0.9 in)

* Custom shape and size available.

DMD-SC-120-240
(12% of panel cut out)

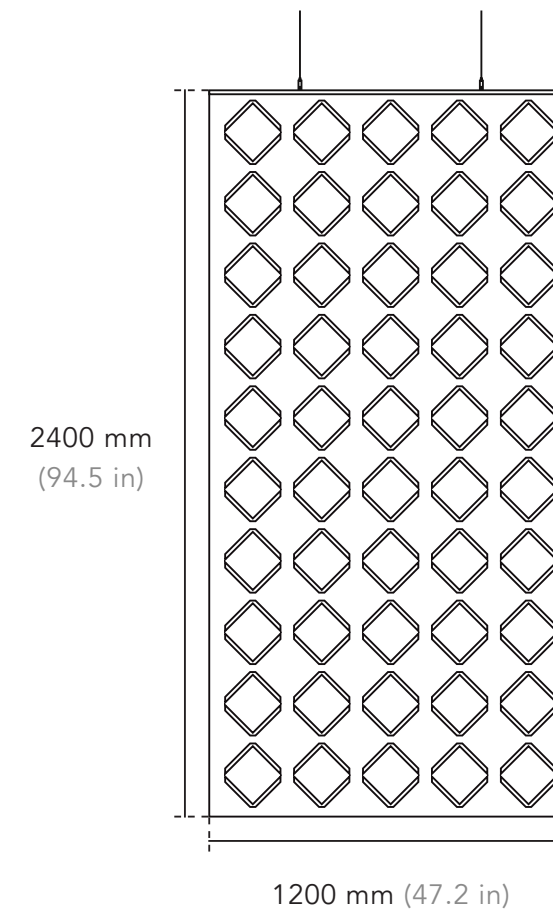

DMD-SC-122-274
(11% of panel cut out)

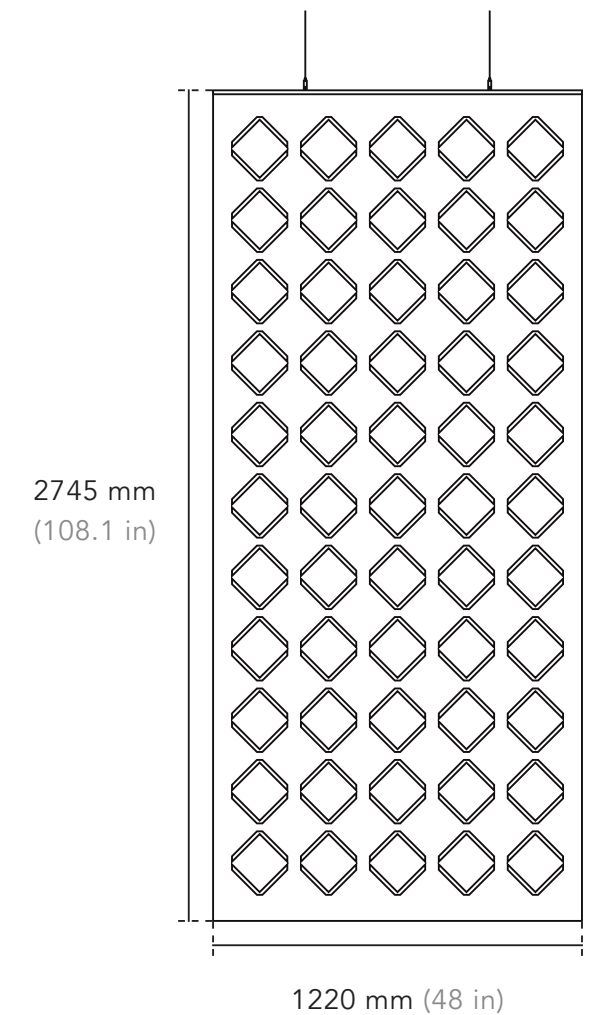

Product Data

Product Code	Width x Height	Thickness	Weight
DMD-SC-120-240	1200 x 2400 mm 47.2 x 94.5 in	12, 18, 24 mm 0.5, 0.7, 0.9 in	6.4, 10.2, 12.7 kg 14.1, 22.5, 28 lb
DMD-SC-122-274	1220 x 2745 mm 48 x 108.1 in	12, 24 mm 0.5, 0.9 in	7.4, 14.9 kg 16.3, 32.8 lb

Specifications

- Product Name** Diamond Screen
- Composition** 100% polyester fibre
- Edge Detail** Square edge
- Fire Rating**
 - ASTM E84 Class A
 - CAN/ULC-S102.2-10
- VOC Emissions** CDPH (CA 01350)
- Antimicrobial Testing** Mould & mildew resistant
- Sustainability**
 - 100% recyclable
 - LBC Red List free
 - Contributes to LEED certification
 - Free of toxic substances and of off-gassing
 - Made with ~60% recycled content from plastic water bottles

- How to Specify**
 - Product Name & Code
 - Dimensions
 - Colour
 - Installation Method

Colour & Texture Variations The felting and dyeing process that forms the material contributes to its unique texture but also to variations in texture and colour from panel to panel. Products will be provided within an acceptable range of variation.



Acoustic Properties

The following values reflect the acoustic properties of the product as tested in accordance with ASTM C423-09a using Type D-50 mounting.

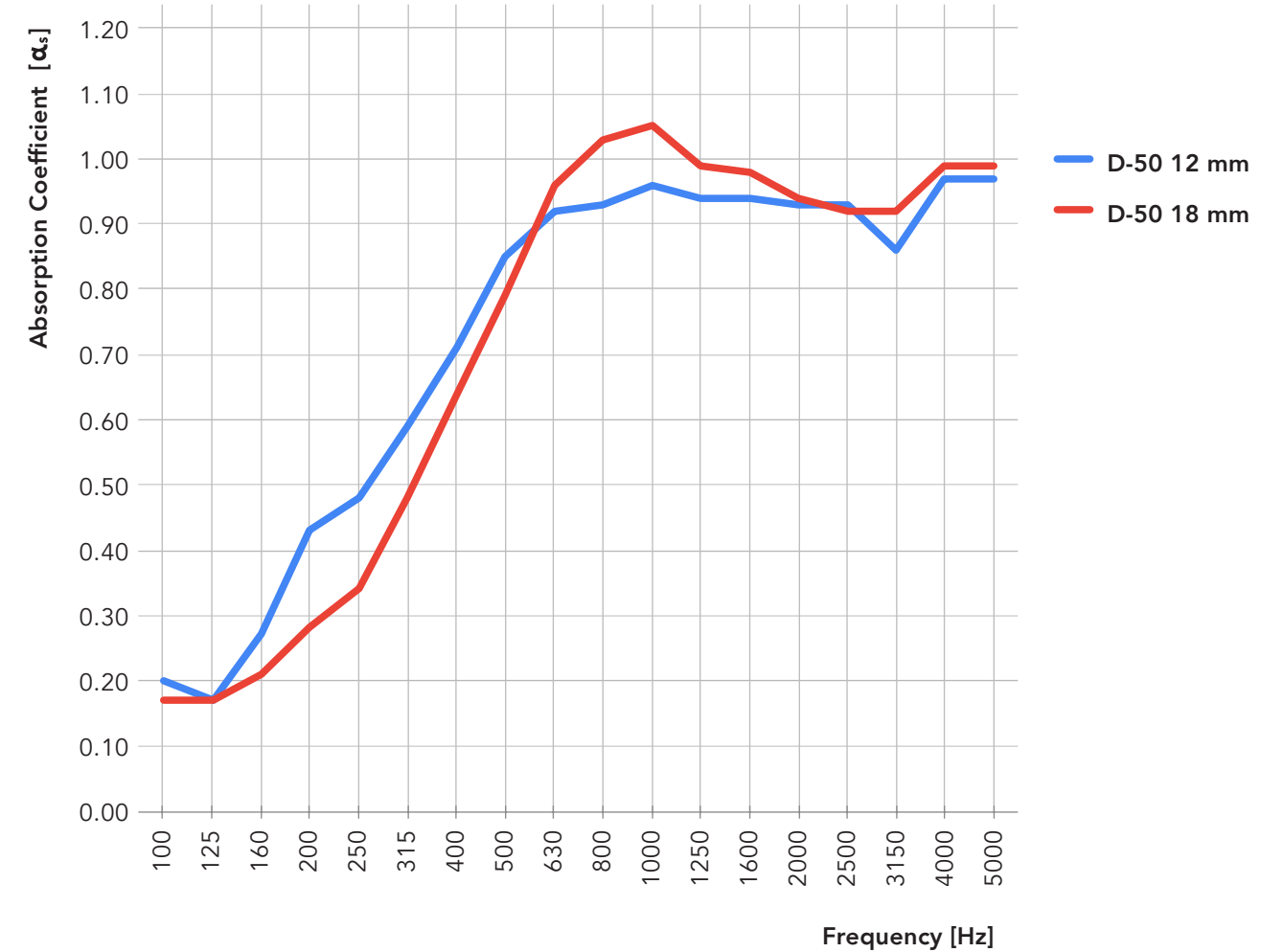

	NRC	SAA	200	250	315	400	500	630	800	1000	1250	1600	2000	2500
D-50 12 mm	0.80	0.80	0.43	0.48	0.59	0.71	0.85	0.92	0.93	0.96	0.94	0.94	0.93	0.93
D-50 18 mm	0.80	0.78	0.28	0.34	0.48	0.64	0.79	0.96	1.03	1.05	0.99	0.98	0.94	0.92

Installation - Aluminum Trim Kit (KT-TRIM-00)

Specify optional ceiling and accessory hardware at the time of ordering.

Ceiling Hardware Options

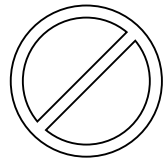

No Hardware
(default)

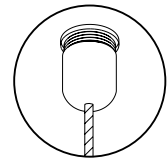

Cable Coupler
(KT-CCPL-00)

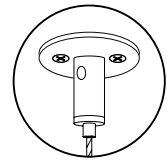

Adjustable Cable Gripper
(KT-CGRP-00)

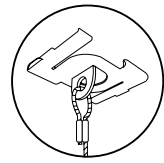

T-bar Clips
(KT-TCLP-00)

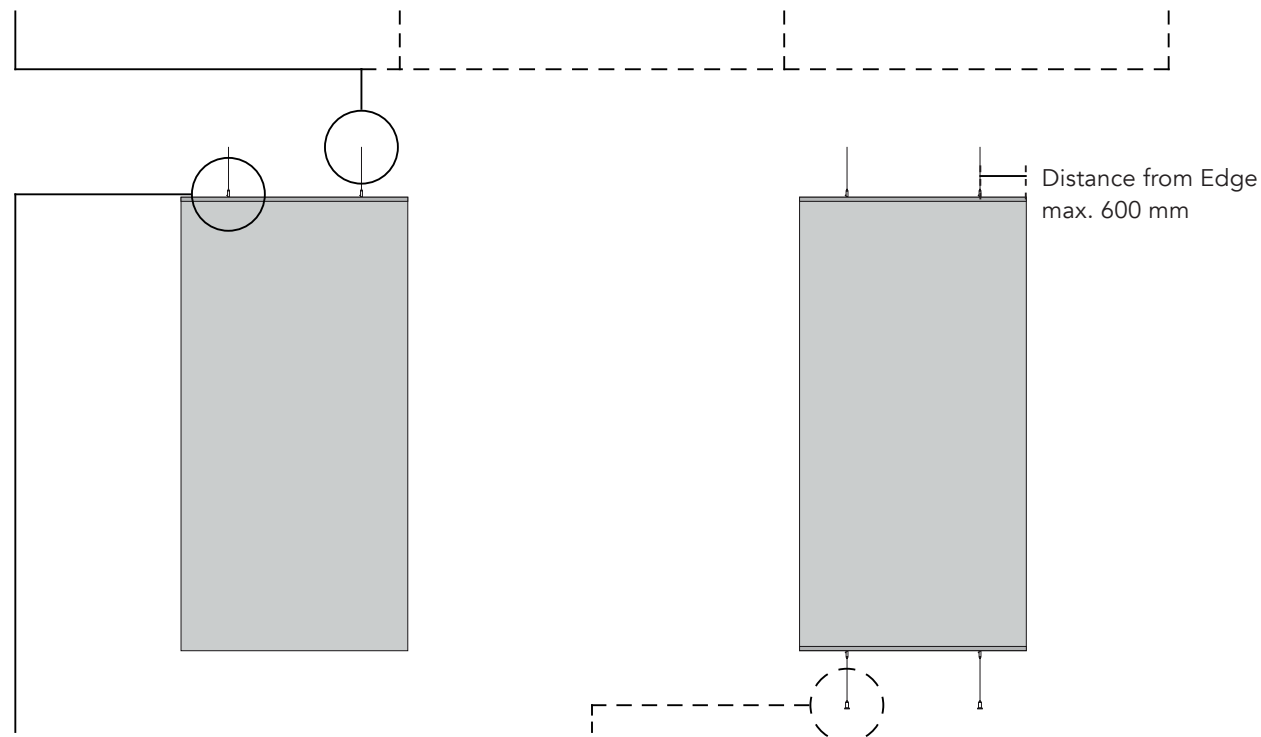

Product Hardware

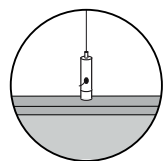

- Aluminum Trim with Adjustable Cable Gripper
- Clear anodized finish (matte black available)
 - Suspension point pre-mounted but can be repositioned on site

Accessory Hardware Option

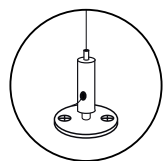

- Floor Mounted Cable Gripper (HW-FGRP-00)

Installation - Sliding Track Kit (KT-SLID-00)

Specify optional accessory hardware at the time of ordering.

Single Row

Track Layout

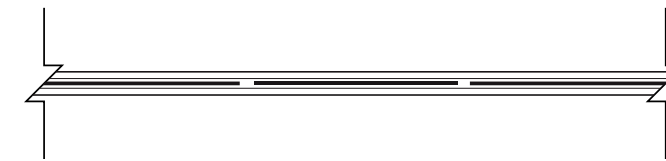

Multiple Rows

Track Layout

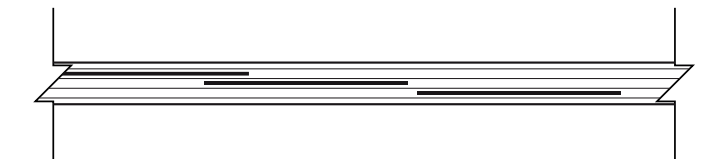

- May be layered in as many rows as desired

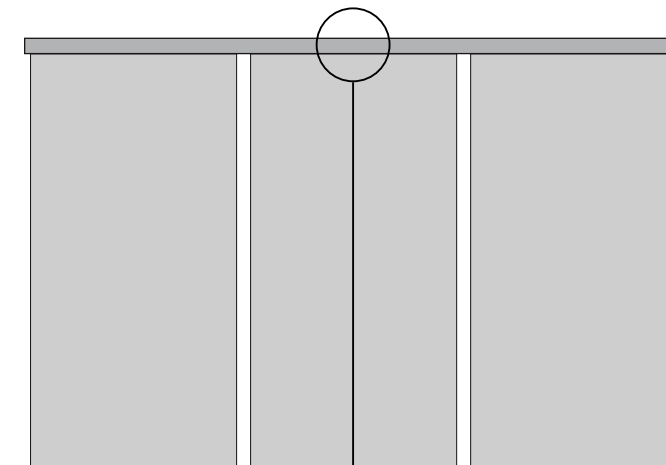

Product Hardware

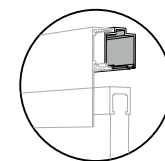

- Sliding Track
- Mill finish
 - Must be mounted to flat, stable & sturdy surface (install blocking if needed)
 - Adds 54-60 mm to the panel height

Accessory Hardware Option

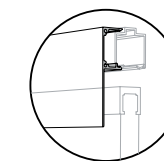

- Track Fascia (HW-FASC-00)
- Clear anodized finish
 - Hides the internals of the track system
 - Clips into place

Product Care

Handling & Storage

Handle products with care so as to avoid folding the polyester felt, chipping its edges or indenting its faces. Store products in their original containers in a well-ventilated area until the intended application environment is ready for installation. Allow products to acclimatize to environmental conditions. Lay them flat on their faces; do not stand them on their edges. Protect from moisture, heat, direct sunlight and the elements.

Maintenance

Lightly brush or gently vacuum to remove dust from polyester felt. Clean with warm water and mild, non-toxic soap to remove spills. Test solution on an inconspicuous spot before applying to more visible areas. Blot with a dry cloth after applying the solution to avoid saturating the material. Avoid applying too much pressure when cleaning the products.

Warranty

AKUSTUS warrants the construction and finish of all our products to be free from defects in material and workmanship for a period of 1 year from the date of purchase.

Colours

* 12/24 mm only



Pure White
SP 07



Urban Grey
SP 79

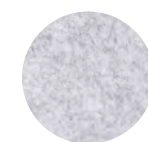

Pumice
SP 11

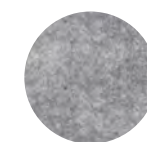

Cool Grey
SP 36

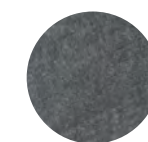

Mid Grey
SP 37



Black
SP 13



Ivory
SP 77



Beige
SP 04



Sandstone
SP 12



Taupe Grey *
SP 90



Warm Grey
SP 76

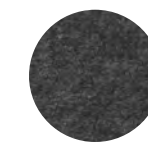

Graphite
SP 03



Castlerock *
SP 80



Blush Pink
SP 81



Plum
SP 72

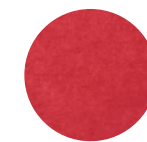

Red
SP 08

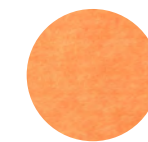

Orange
SP 46

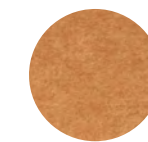

Yam
SP 28



Mustard *
SP 87

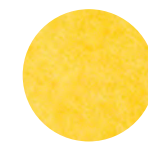

Sunflower
SP 05



Chartreuse
SP 43

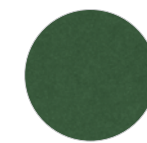

Moss *
SP 89

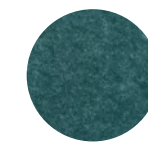

Peacock *
SP 82

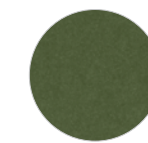

Olive *
SP 88

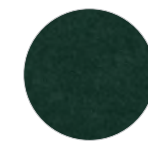

Ocean Green *
SP 86

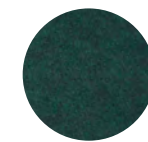

Forest Green
SP 17

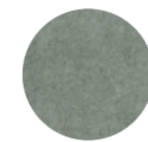

Desert Sage
SP 78



Deep Sea Blue *
SP 83



Krypton
SP 30

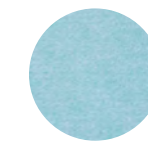

Pale Teal
SP 74



Lagoon *
SP 84

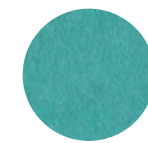

Aquamarine
SP 73

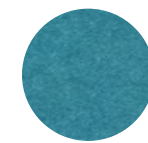

Dark Turquoise
SP 71



Azure *
SP 85

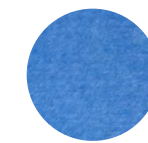

Sky Blue
SP 25



Navy
SP 01

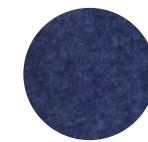

Midnight Blue
SP 19



Purple
SP 50