



Valley Baffle

BY AKUSTUS DESIGNS





VAL-BF-A-033-240

The dips and slopes of **Valley Baffle** create fascinating visuals from no matter which angle you view them from. While the panel material absorbs excess sound energy, the slanted faces of the baffle cause sound waves to reflect and diffuse more evenly within the room. Let Valley help you create a room that's wonderful to be in and to look at.

Dimensions - Individual Baffles

* Custom shape and size available.

VAL-BF-A-033-xxx

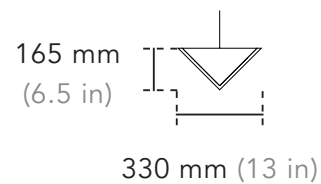

VAL-BF-B-020-xxx

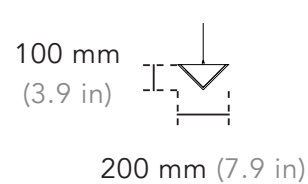

VAL-BF-x-xxx-072

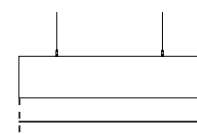

VAL-BF-x-xxx-114

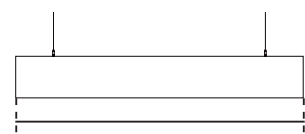

VAL-BF-x-xxx-161

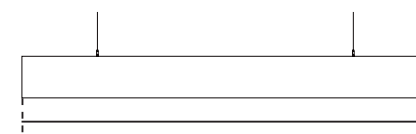

VAL-BF-x-xxx-082

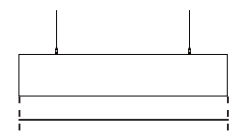

VAL-BF-x-xxx-129

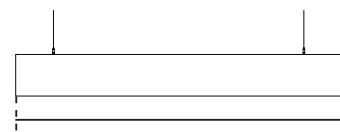

VAL-BF-x-xxx-171

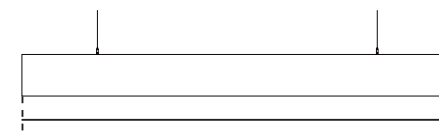

VAL-BF-x-xxx-087

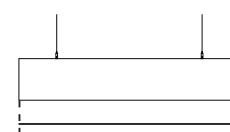

VAL-BF-x-xxx-145

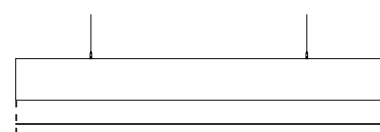

VAL-BF-x-xxx-244

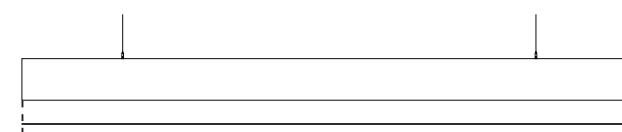

VAL-BF-x-xxx-097

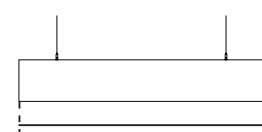

VAL-BF-x-xxx-156

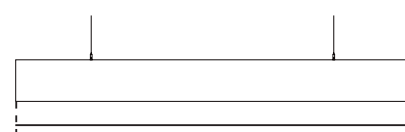

VAL-BF-x-xxx-274

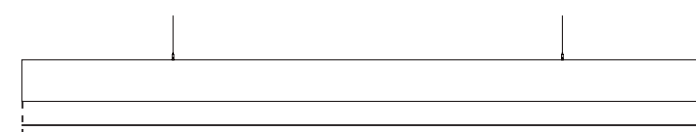

Product Data

Product Code	Width	Length	Height
VAL-BF-A-033-072 / VAL-BF-B-020-072	330 / 200 mm 13 / 7.9 in	720 mm 28.3 in	165 / 100 mm 6.5 / 3.9 in
VAL-BF-A-033-082 / VAL-BF-B-020-082	330 / 200 mm 13 / 7.9 in	827 mm 32.6 in	165 / 100 mm 6.5 / 3.9 in
VAL-BF-A-033-087 / VAL-BF-B-020-087	330 / 200 mm 13 / 7.9 in	877 mm 34.5 in	165 / 100 mm 6.5 / 3.9 in
VAL-BF-A-033-097 / VAL-BF-B-020-097	330 / 200 mm 13 / 7.9 in	972 mm 38.3 in	165 / 100 mm 6.5 / 3.9 in
VAL-BF-A-033-114 / VAL-BF-B-020-114	330 / 200 mm 13 / 7.9 in	1141 mm 44.9 in	165 / 100 mm 6.5 / 3.9 in
VAL-BF-A-033-129 / VAL-BF-B-020-129	330 / 200 mm 13 / 7.9 in	1293.5 mm 50.9 in	165 / 100 mm 6.5 / 3.9 in
VAL-BF-A-033-145 / VAL-BF-B-020-145	330 / 200 mm 13 / 7.9 in	1455 mm 57.3 in	165 / 100 mm 6.5 / 3.9 in
VAL-BF-A-033-156 / VAL-BF-B-020-156	330 / 200 mm 13 / 7.9 in	1562 mm 61.5 in	165 / 100 mm 6.5 / 3.9 in
VAL-BF-A-033-161 / VAL-BF-B-020-161	330 / 200 mm 13 / 7.9 in	1615 mm 63.6 in	165 / 100 mm 6.5 / 3.9 in
VAL-BF-A-033-171 / VAL-BF-B-020-171	330 / 200 mm 13 / 7.9 in	1710 mm 67.3 in	165 / 100 mm 6.5 / 3.9 in
VAL-BF-A-033-244 / VAL-BF-B-020-244	330 / 200 mm 13 / 7.9 in	2440 mm 96.1 in	165 / 100 mm 6.5 / 3.9 in
VAL-BF-A-033-274 / VAL-BF-B-020-274	330 / 200 mm 13 / 7.9 in	2745 mm 108.1 in	165 / 100 mm 6.5 / 3.9 in

Dimensions - Baffle Cloud

* Custom shape and size available.

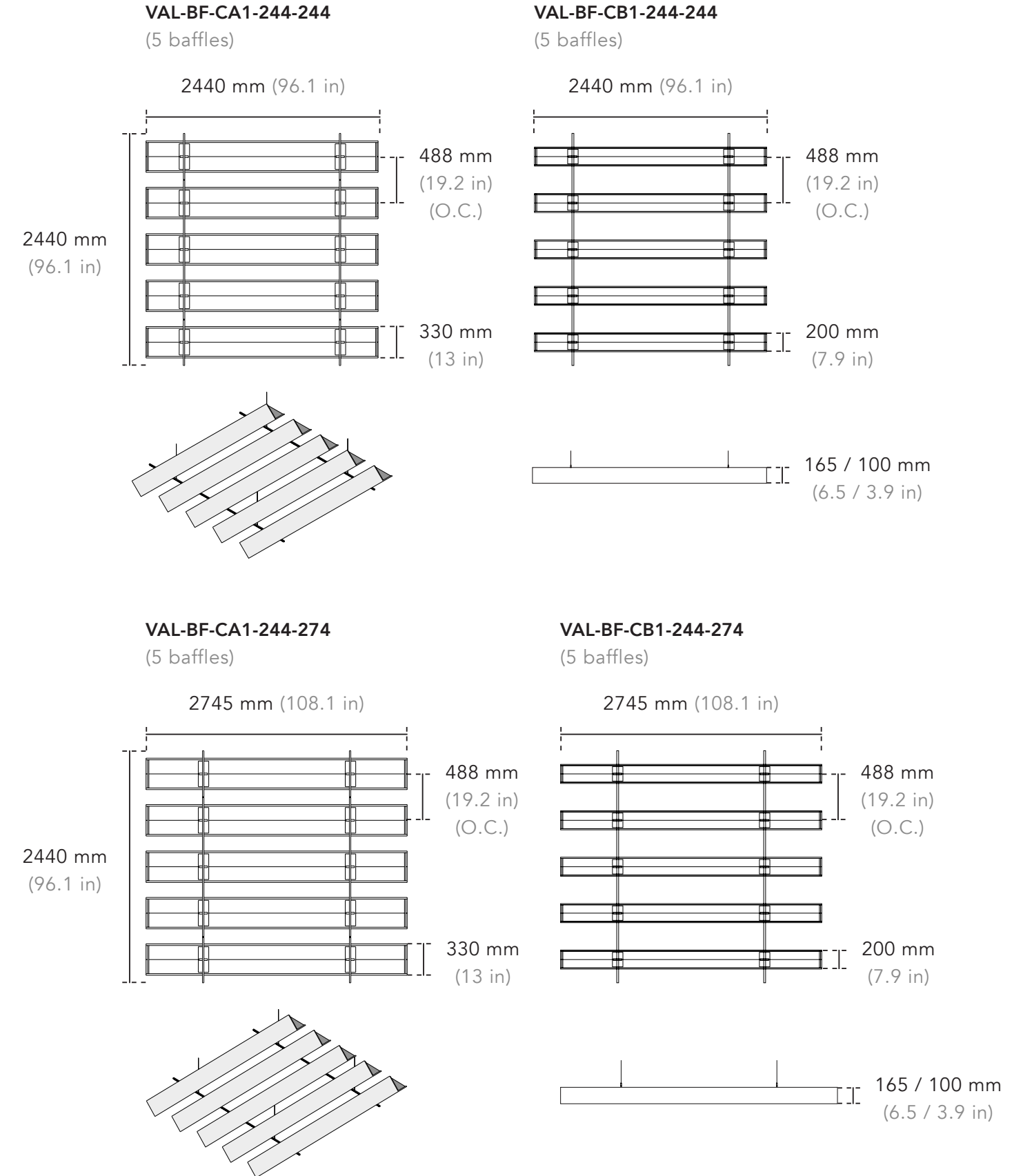

Dimensions - Baffle Cloud

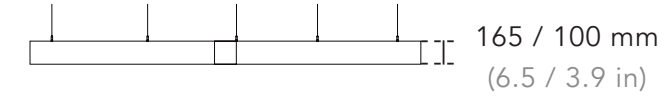
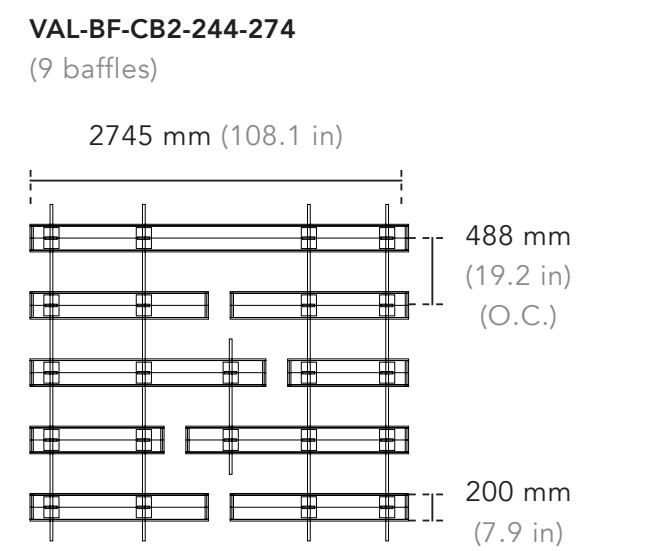
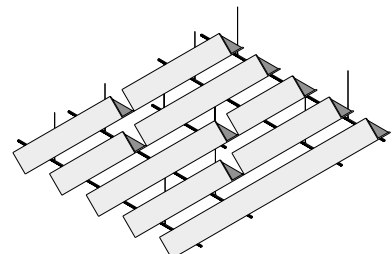
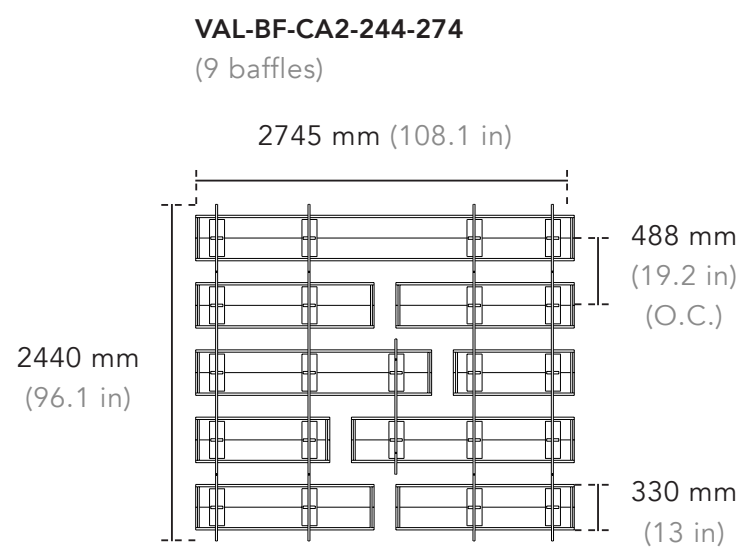
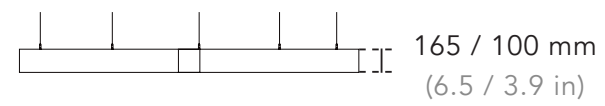
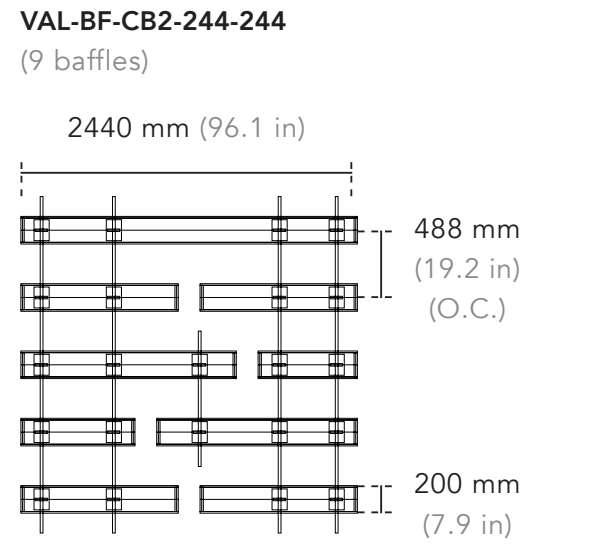
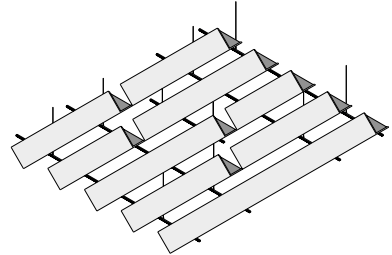
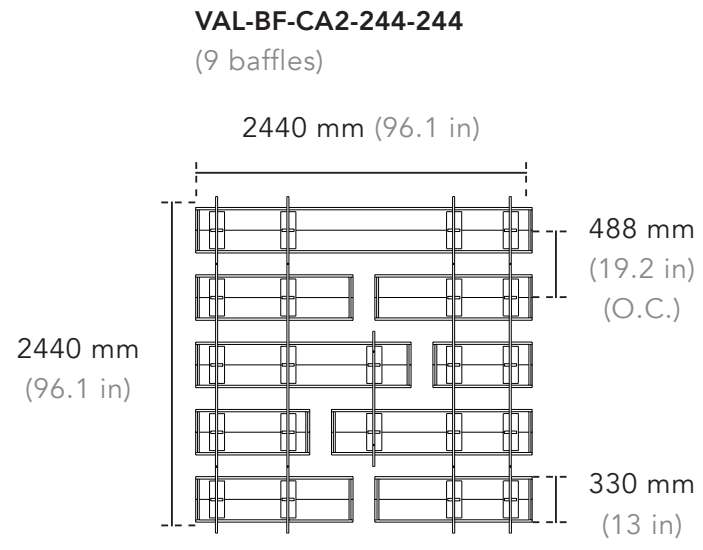

Product Data

Product Code	Width x Length x Height	Spacing	Baffle Width
VAL-BF-CA1-244-244	2440 x 2440 x 165 mm 96.1 x 96.1 x 6.5 in	488 mm 19.2 in	330 mm 13 in
VAL-BF-CA1-244-274	2440 x 2745 x 165 mm 96.1 x 108.1 x 6.5 in	488 mm 19.2 in	330 mm 13 in
VAL-BF-CA2-244-244	2440 x 2440 x 165 mm 96.1 x 96.1 x 6.5 in	488 mm 19.2 in	330 mm 13 in
VAL-BF-CA2-244-274	2440 x 2745 x 165 mm 96.1 x 108.1 x 6.5 in	488 mm 19.2 in	330 mm 13 in
VAL-BF-CB1-244-244	2440 x 2440 x 100 mm 96.1 x 96.1 x 3.9 in	488 mm 19.2 in	200 mm 7.9 in
VAL-BF-CB1-244-274	2440 x 2745 x 100 mm 96.1 x 108.1 x 3.9 in	488 mm 19.2 in	200 mm 7.9 in
VAL-BF-CB2-244-244	2440 x 2440 x 100 mm 96.1 x 96.1 x 3.9 in	488 mm 19.2 in	200 mm 7.9 in
VAL-BF-CB2-244-274	2440 x 2745 x 100 mm 96.1 x 108.1 x 3.9 in	488 mm 19.2 in	200 mm 7.9 in

Specifications

Product Name	Valley Baffle
Composition	100% polyester fibre
Fire Rating	<ul style="list-style-type: none"> • ASTM E84 Class A • CAN/ULC-S102.2-10
VOC Emissions	CDPH (CA 01350)
Antimicrobial Testing	Mould & mildew resistant
Sustainability	<ul style="list-style-type: none"> • 100% recyclable • LBC Red List free • Contributes to LEED certification • Free of toxic substances and of off-gassing • Made with ~60% recycled content from plastic water bottles

How to Specify	<ul style="list-style-type: none"> • Product Name & Code • Dimensions • Colour • Installation Method
-----------------------	--

Colour & Texture Variations
 The felting and dyeing process that forms the material contributes to its unique texture but also to variations in texture and colour from panel to panel. Products will be provided within an acceptable range of variation.



Acoustic Properties

The following values reflect the acoustic properties of the product as tested in accordance with ASTM C423-09a using Type J mounting.

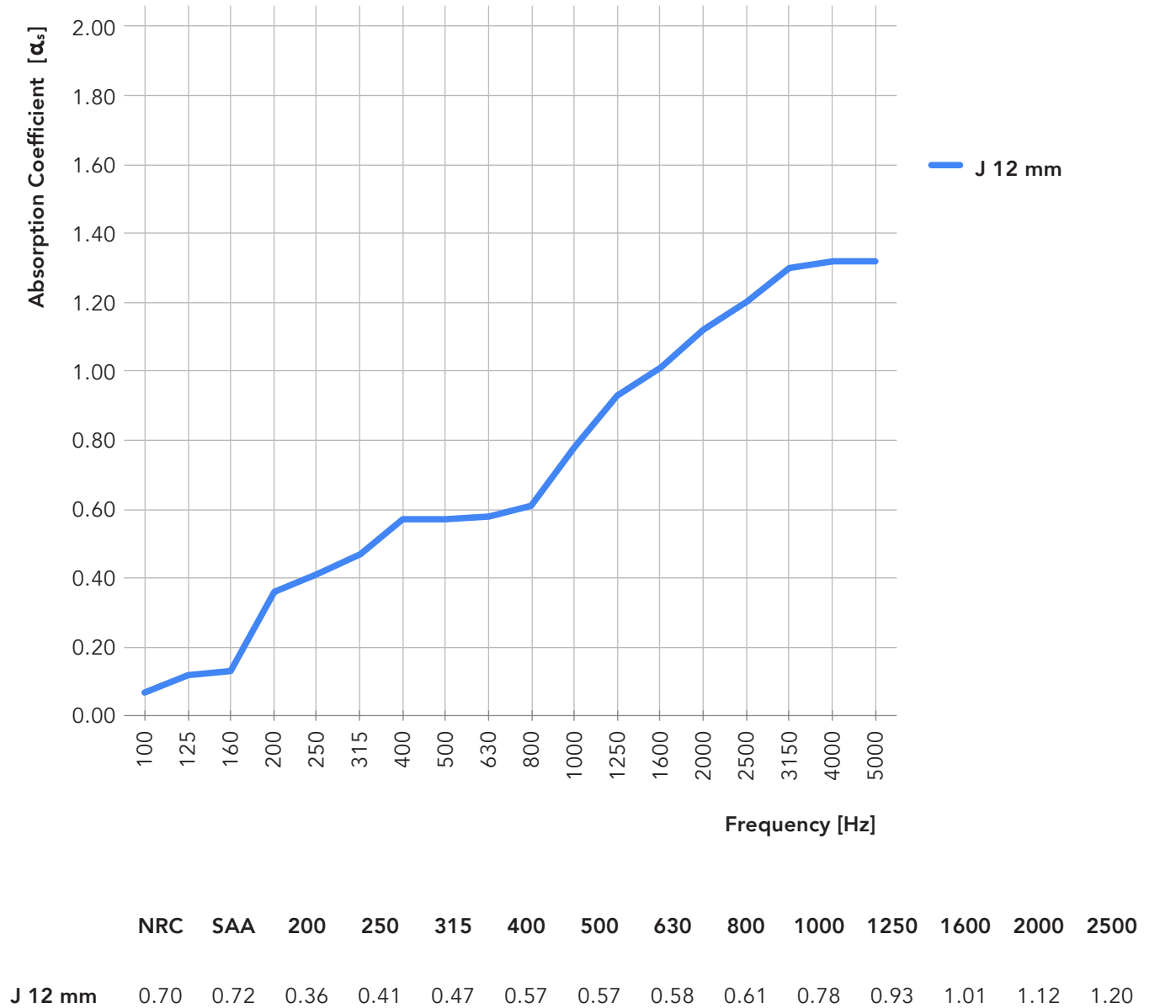

Installation - Valley Baffle Kit (KT-VABF-00)

Specify optional ceiling and accessory hardware at the time of ordering.

Ceiling Hardware Options

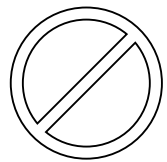

No Hardware
(default)

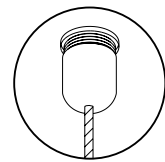

Cable Coupler
(KT-CCPL-00)

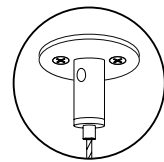

Adjustable Cable Gripper
(KT-CGRP-00)

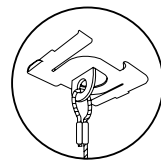

T-bar Clips
(KT-TCLP-00)

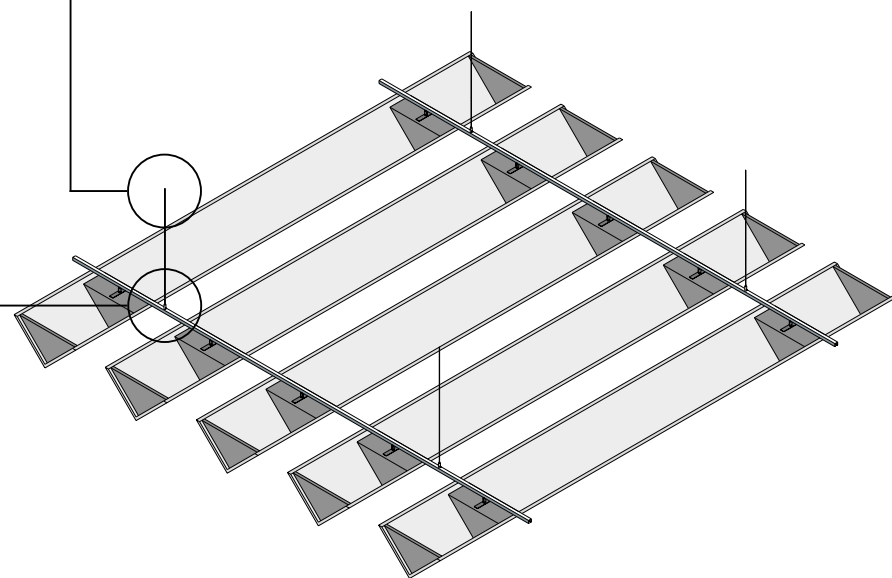

Product Hardware

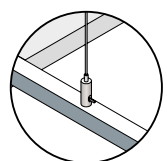

Aluminum Channel with
Adjustable Cable Gripper

- Clear anodized finish
(matte black available)
- Suspension point pre-mounted but can be repositioned on site

Product Care

Handling & Storage

Handle products with care so as to avoid folding the polyester felt, chipping its edges or indenting its faces. Store products in their original containers in a well-ventilated area until the intended application environment is ready for installation. Allow products to acclimatize to environmental conditions. Lay them flat on their faces; do not stand them on their edges. Protect from moisture, heat, direct sunlight and the elements.

Maintenance

Lightly brush or gently vacuum to remove dust from polyester felt. Clean with warm water and mild, non-toxic soap to remove spills. Test solution on an inconspicuous spot before applying to more visible areas. Blot with a dry cloth after applying the solution to avoid saturating the material. Avoid applying too much pressure when cleaning the products.

Warranty

AKUSTUS warrants the construction and finish of all our products to be free from defects in material and workmanship for a period of 1 year from the date of purchase.

Colours

* 12/24 mm only



Pure White
SP 07



Urban Grey
SP 79



Pumice
SP 11

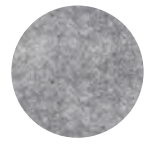

Cool Grey
SP 36

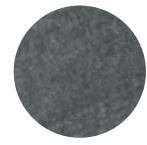

Mid Grey
SP 37



Black
SP 13



Ivory
SP 77



Beige
SP 04



Sandstone
SP 12



Taupe Grey *
SP 90



Warm Grey
SP 76

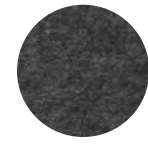

Graphite
SP 03



Castlerock *
SP 80



Blush Pink
SP 81



Plum
SP 72

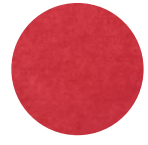

Red
SP 08



Orange
SP 46

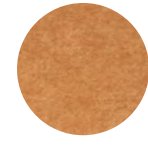

Yam
SP 28



Mustard *
SP 87

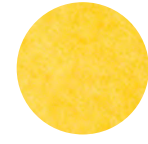

Sunflower
SP 05



Chartreuse
SP 43



Moss *
SP 89

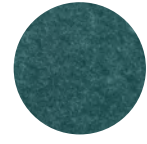

Peacock *
SP 82



Olive *
SP 88



Ocean Green *
SP 86

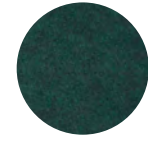

Forest Green
SP 17

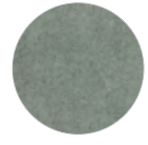

Desert Sage
SP 78



Deep Sea Blue *
SP 83



Krypton
SP 30

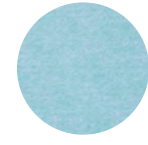

Pale Teal
SP 74



Lagoon *
SP 84

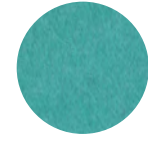

Aquamarine
SP 73



Dark Turquoise
SP 71



Azure *
SP 85



Sky Blue
SP 25



Navy
SP 01

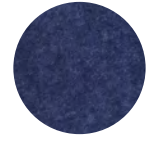

Midnight Blue
SP 19



Purple
SP 50

