

Forma Floor Divider

BY AKUSTUS DESIGNS



[AKUSTUS.COM](https://akustus.com)

[INFO@AKUSTUS.COM](mailto:info@akustus.com)



FMA-FD-A-067-130, FMA-FD-A-078-150, FMA-FD-B-055-130 & FMA-FD-B-063-150

Funky geometry and dramatic colours come together in the **Forma Floor Divider** series. Each piece utilizes a boxy structure and an eye-catching silhouette to create an unforgettable space.

Dimensions

Available Thicknesses: 75 mm (3 in)

* Custom shape and size available.

**FMA-FD-A-067-130
(Module A)**

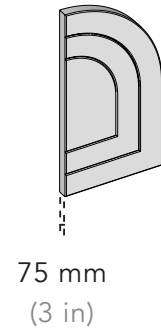
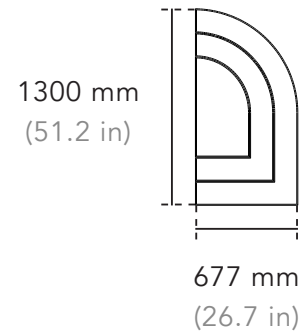

**FMA-FD-A-078-150
(Module A)**

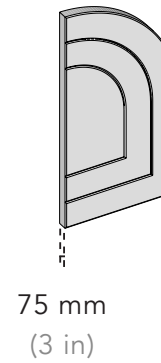
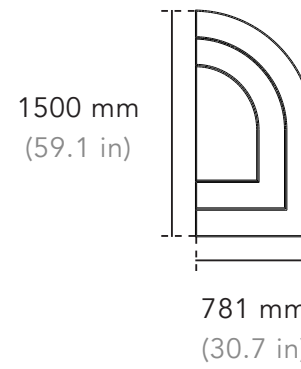

**FMA-FD-A-093-180
(Module A)**

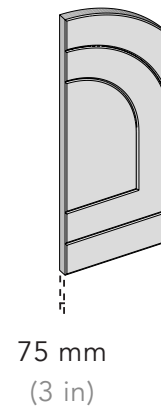
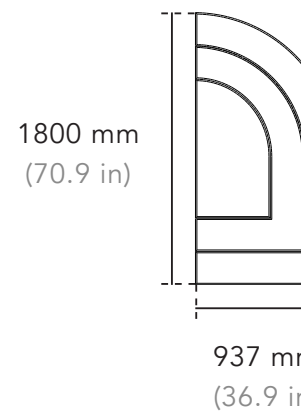

Product Data

Product Code	Width	Height	Depth
FMA-FD-A-067-130	677 mm 26.7 in	1300 mm 51.2 in	75 mm 3 in
FMA-FD-A-078-150	781 mm 30.7 in	1500 mm 59.1 in	75 mm 3 in
FMA-FD-A-093-180	937 mm 36.9 in	1800 mm 70.9 in	75 mm 3 in

Dimensions

Available Thicknesses: 75 mm (3 in)

* Custom shape and size available.

**FMA-FD-B-055-130
(Module B)**

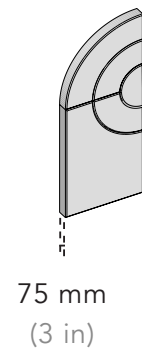
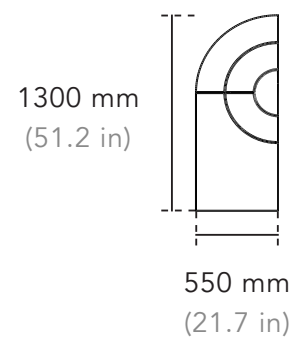

**FMA-FD-B-063-150
(Module B)**

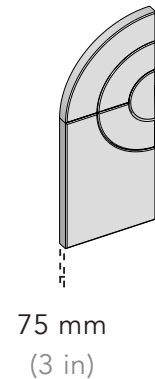
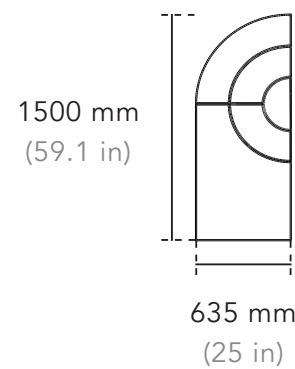

**FMA-FD-B-076-180
(Module B)**

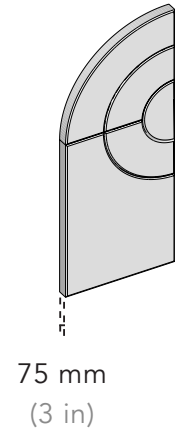
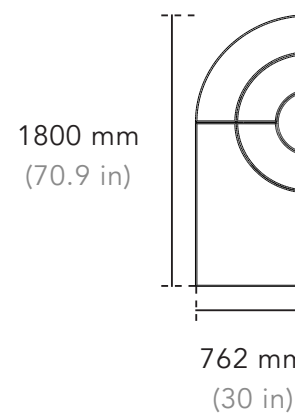

Product Data

Product Code	Width	Height	Depth
FMA-FD-B-055-130	550 mm 21.7 in	1300 mm 51.2 in	75 mm 3 in
FMA-FD-B-063-150	635 mm 25 in	1500 mm 59.1 in	75 mm 3 in
FMA-FD-B-076-180	762 mm 30 in	1800 mm 70.9 in	75 mm 3 in

Dimensions

Available Thicknesses: 75 mm (3 in)

* Custom shape and size available.

FMA-FD-C-072-130
(Module C)

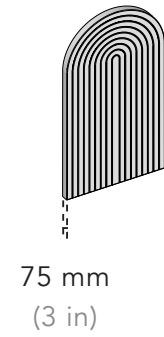
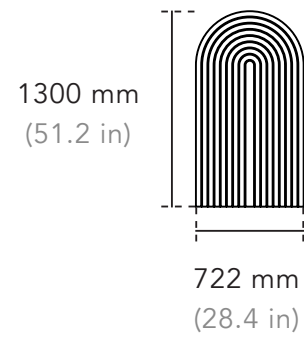

FMA-FD-C-083-150
(Module C)

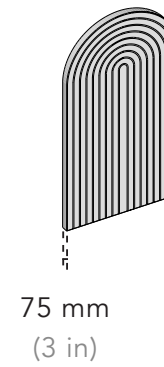
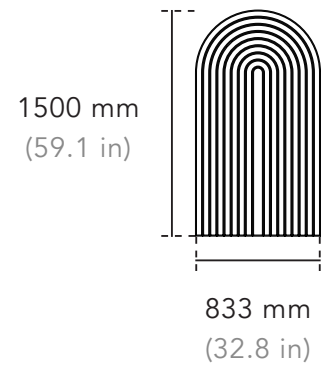

FMA-FD-C-100-180
(Module C)

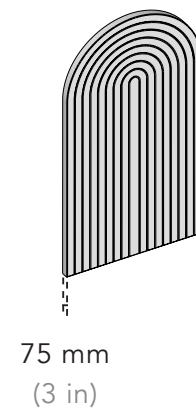
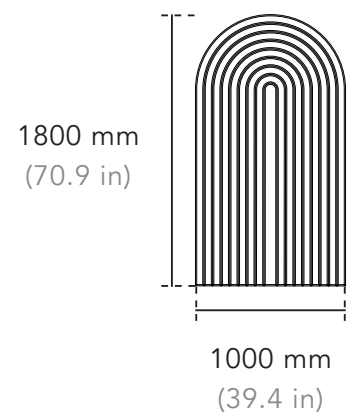

Product Data

Product Code	Width	Height	Depth
FMA-FD-C-072-130	722 mm 28.4 in	1300 mm 51.2 in	75 mm 3 in
FMA-FD-C-083-150	833 mm 32.8 in	1500 mm 59.1 in	75 mm 3 in
FMA-FD-C-100-180	1000 mm 39.4 in	1800 mm 70.9 in	75 mm 3 in

Specifications

Product Name	Forma Floor Divider
Composition	100% polyester fibre
Edge Detail	Box edge
Fire Rating	<ul style="list-style-type: none"> • ASTM E84 Class A • CAN/ULC-S102.2-10
VOC Emissions	CDPH (CA 01350)
Antimicrobial Testing	Mould & mildew resistant
Sustainability	<ul style="list-style-type: none"> • 100% recyclable • LBC Red List free • Contributes to LEED certification • Free of toxic substances and of off-gassing • Made with ~60% recycled content from plastic water bottles

How to Specify	<ul style="list-style-type: none"> • Product Name & Code • Dimensions • Colour • Installation Method
-----------------------	--

Colour & Texture Variations The felting and dyeing process that forms the material contributes to its unique texture but also to variations in texture and colour from panel to panel. Products will be provided within an acceptable range of variation.



Acoustic Properties

The following values reflect the acoustic properties of the product as tested in accordance with ASTM C423-09a using Type J mounting.

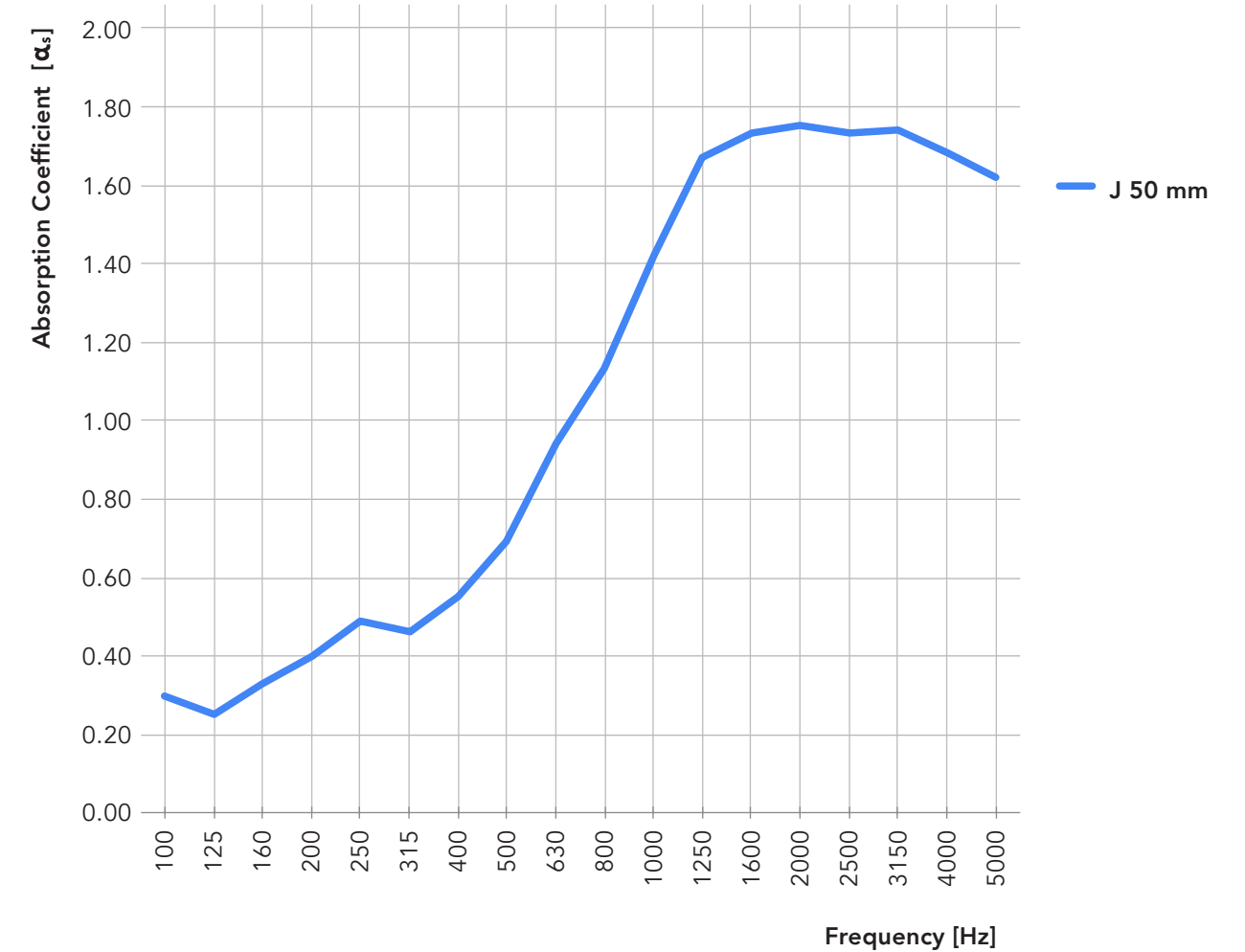

	NRC	SAA	200	250	315	400	500	630	800	1000	1250	1600	2000	2500
J 50 mm	1.10	1.08	0.40	0.49	0.46	0.55	0.69	0.94	1.13	1.42	1.67	1.73	1.75	1.73

Installation

Specify installation method at the time of ordering.

- Aluminum Base Plate
- Aluminum Base Plate with Castors

Product Care

Handling & Storage

Handle products with care so as to avoid folding the polyester felt, chipping its edges or indenting its faces. Store products in their original containers in a well-ventilated area until the intended application environment is ready for installation. Allow products to acclimatize to environmental conditions. Lay them flat on their faces; do not stand them on their edges. Protect from moisture, heat, direct sunlight and the elements.

Maintenance

Lightly brush or gently vacuum to remove dust from polyester felt. Clean with warm water and mild, non-toxic soap to remove spills. Test solution on an inconspicuous spot before applying to more visible areas. Blot with a dry cloth after applying the solution to avoid saturating the material. Avoid applying too much pressure when cleaning the products.

Warranty

AKUSTUS warrants the construction and finish of all our products to be free from defects in material and workmanship for a period of 1 year from the date of purchase.

Colours



Pure White
SP 07



Krypton
SP 30



Urban Grey
SP 79

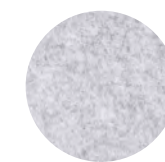

Pumice
SP 11



Warm Grey
SP 76

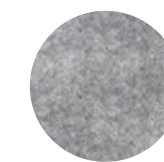

Cool Grey
SP 36



Ivory
SP 77



Beige
SP 04



Sandstone
SP 12

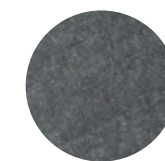

Mid Grey
SP 37

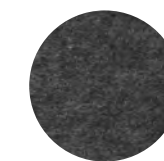

Graphite
SP 03



Black
SP 13

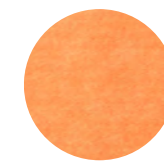

Orange
SP 46

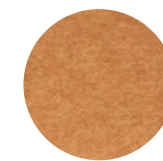

Yam
SP 28



Wild Currant
SP 48



Plum
SP 72

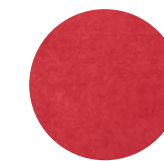

Red
SP 08



Blush Pink
SP 81

NEW

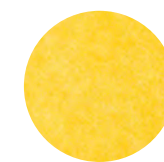

Sunflower
SP 05



Chartreuse
SP 43

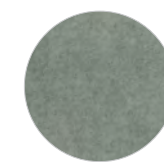

Desert Sage
SP 78

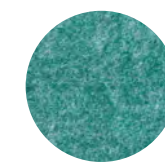

Green
SP 10

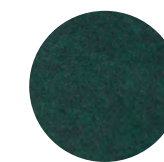

Forest Green
SP 17

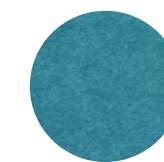

Dark Turquoise
SP 71

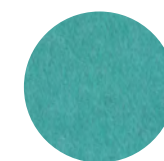

Aquamarine
SP 73



Pale Teal
SP 74

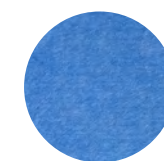

Sky Blue
SP 25



Navy
SP 01

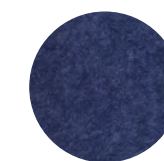

Midnight Blue
SP 19

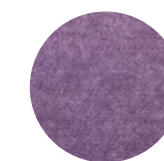

Purple
SP 50